



AUTOMATIC ENTRANCE SPECIALISTS

PAM23

IP2038
rev. 2009-09-15

- I** Manuale di assemblaggio e installazione serramenti PAM23.
- GB** Assembly and installation manual for PAM23 door frame.
- F** Manuel d'assemblage et d'installation d'huisseries PAM23.
- D** Anleitung für Zusammenbau und Installation der Fenster PAM23.
- E** Manual de ensamblaje e instalación cierres PAM23.
- P** Manual de montagem e instalação de ferragens PAM23.

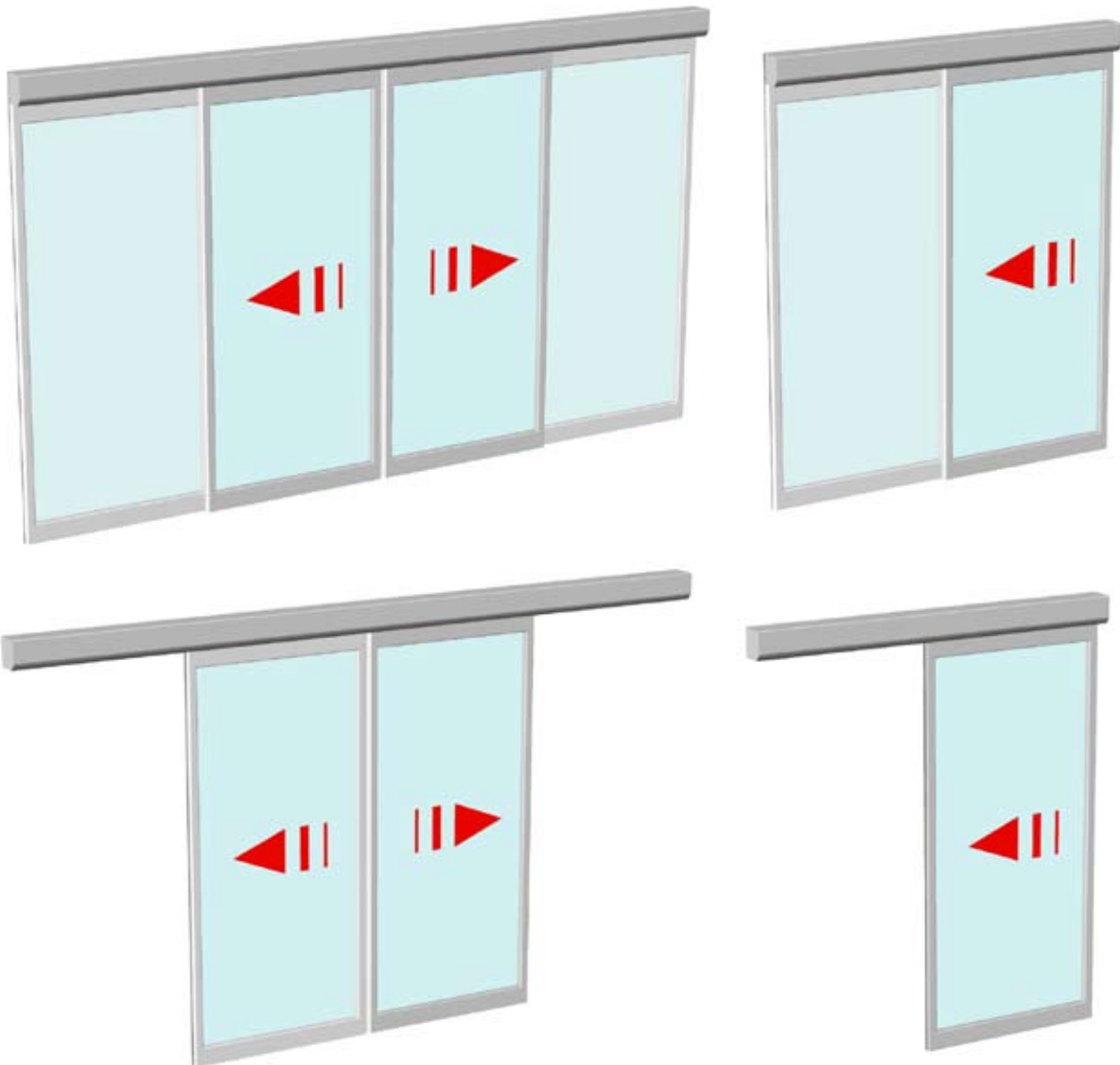

DITEC S.p.A.
Via Mons. Banfi, 3 - 21042 Caronno Pertusella (VA) - ITALY
Tel. +39 02 963911 - Fax +39 02 9650314
www.ditec.it - ditec@ditecva.com

ISO 9001
Cert. n° 0957

INDICE - INDEX - INDEX - INHALTSVERZEICHNIS - ÍNDICE - INDEX

PAG.		
5	Sagomario Master templates list List de gabarits	Schablonen Liste Lista de sáomas Lista do perfis
7	Kit componenti Components kit Kit composants	Komponentenkit Kit componentes Conjunto de componentes
11	Spessore vetri Glass thickness Epaisseur des vitres	Glasstärke Espesor cristales Espessura dos vidros
12	Sezioni verticale e orizzontale 2 ante mobili + 2 ante fisse Vertical and horizontal sections 2 moving wings + 2 fixed wings Section verticale et horizontale 2 vantaux mobiles + 2 vantaux fixes	Vertikal- und Horizontalschnitte 2 Fahrflügel + 2 Seitenteile Secciones vertical y horizontal 2 hojas móviles + 2 hojas fijas Secções vertical e horizontal 2 portinholas móveis + 2 portinholas fixas
14	Distinta di taglio 2 ante mobili + 2 ante fisse Cutting list 2 moving door wings + 2 fixed door wings Liste dimensionnelle 2 vantaux mobiles + 2 vantaux fixes	Schnittbeschreibung 2 Fahrflügel + 2 Seitenteile Detalle de corte 2 hojas móviles + 2 hojas fijas Lista de corte 2 portinholas móveis + 2 portinholas fixas
16	Sezioni verticale e orizzontale 2 ante mobili Vertical and horizontal sections 2 moving wings Section verticale et horizontale 2 vantaux mobiles	Vertikal- und Horizontalschnitte 2 Fahrflügel Secciones vertical y horizontal 2 hojas móviles Secções vertical e horizontal 2 portinholas móveis
18	Distinta di taglio 2 ante mobili Cutting list 2 moving door wings Liste dimensionnelle 2 vantaux mobiles	Schnittbeschreibung 2 Fahrflügel Detalle de corte 2 hojas móviles Lista de corte 2 portinholas móveis
19	Sezioni verticale e orizzontale 1 anta mobile + 1 anta fissa Vertical and horizontal sections 1 moving wing + 1 fixed wing Section verticale et horizontale 1 vantail mobile + 1 vantail fixe	Vertikal- und Horizontalschnitte 1 Fahrflügel + 1 Seitenteil Secciones vertical y horizontal 1 hoja móvil + 1 hoja fija Secções vertical e horizontal 1 portinhola móvel + 1 portinhola fixa
21	Distinta di taglio 1 anta mobile + 1 anta fissa Cutting list 1 moving door wing + 1 fixed door wing Liste dimensionnelle 1 vantail mobile + 1 vantail fixe	Schnittbeschreibung 1 Fahrflügel + 1 Seitenteil Detalle de corte 1 hoja móvil + 1 hoja fija Lista de corte 1 portinhola móvel + 1 portinhola fixa
22	Sezioni verticale e orizzontale 1 anta mobile Vertical and horizontal sections 1 moving wing Section verticale et horizontale 1 vantail mobile	Vertikal- und Horizontalschnitte 1 Fahrflügel Secciones vertical y horizontal 1 hoja móvil Secções vertical e horizontal 1 portinhola móvel
24	Distinta di taglio 1 anta mobile Cutting list 1 moving door wing Liste dimensionnelle 1 vantail mobile	Schnittbeschreibung 1 Fahrflügel Detalle de corte 1 hoja móvil Lista de corte 1 portinhola móvel
25	Sezione verticale automazione REX Vertical sections REX automation Section verticale automation REX	REX Automation Vertikalschnitte Secciones vertical automatización REX Secções vertical automatização REX
27	Sezione verticale automazione TEN Vertical sections TEN automation Section verticale automation TEN	TEN Automation Vertikalschnitte Secciones vertical automatización TEN Secções vertical automatização TEN

LEGENDA - CAPTION - LEGENDE - LEGENDE - LEYENDA - LEGENDA

	I	GB	F	D	E	P
L	Larghezza utile vano muro	Useful width	Largeur utile de l'ouverture du mur	Nutzbare Breite der Wandöffnung	Anchura útil cavidad pared	Largura útil do vão da parede
PL	Larghezza vano passaggio	Doorway width	Largeur de la baie de passage	Breite des Platzbedarfs für die Öffnung	Anchura espacio paso	Largura do vão de passagem
LT	Lunghezza automazione	Drive unit length	Longueur de l'automatisme	Länge des Antriebs	Longitud automatismo	Comprimento automação
LF	Larghezza anta fissa	Fixed door wing width	Largeur du vantail fixe	Breite des Seitenteils	Anchura hoja fija	Largura da portinhola fixa
LVF	Larghezza vetro anta fissa	Fixed door wing glazing width	Largeur de la vitre du vantail fixe	Breite der Scheibe des Seitenteils	Anchura cristal hoja fija	Largura do vidro da portinhola fixa
LM	Larghezza anta mobile	Moving door wing width	Largeur du vantail mobile	Breite des Fahrflügels	Anchura hoja móvil	Largura da portinhola móvel
LVM	Larghezza vetro anta mobile	Moving door wing glazing width	Largeur de la vitre du vantail mobile	Breite der Scheibe des Fahrflügels	Anchura cristal hoja móvil	Largura vidro da portinhola móvel
H	Altezza utile vano muro	Useful height	Hauteur utile de l'ouverture du mur	Nutzbare Höhe der Wandöffnung	Altura útil cavidad pared	Altura útil do vão da parede
PH	Altezza vano passaggio	Doorway height	Hauteur de la baie de passage	Lichte Höhe	Altura espacio paso	Altura do vão de passagem
H1	Altezza utile sotto trave	Useful height under beam	Hauteur utile sous le montant	Nutzbare Höhe unter dem Kämpfer	Altura útil debajo de viga	Altura útil abaixo de trave
HF	Altezza anta fissa	Fixed door wing height	Hauteur du vantail fixe	Höhe des Seitenteils	Altura hoja fija	Altura da portinhola fixa
HVF	Altezza vetro anta fissa	Fixed door wing glazing height	Hauteur de la vitre du vantail fixe	Höhe der Scheibe des Seitenteils	Altura cristal hoja fija	Altura do vidro da portinhola fixa
HM	Altezza anta mobile	Moving door wing height	Hauteur du vantail mobile	Höhe des Fahrflügels	Altura hoja móvil	Altura da portinhola móvel
HVM	Altezza vetro anta mobile	Moving door wing glazing height	Hauteur de la vitre du vantail mobile	Höhe der Scheibe des Fahrflügels	Altura cristal hoja móvil	Altura do vidro da portinhola móvel



PROFILI SERIE PAM23

Le prove effettuate in laboratorio ed in sede d'opera conducono ad una portata massima dell'anta di 120 kg.

Per una verifica strutturale più accurata, verificare i momenti di inerzia per profili portanti (dis. n. 4064 e 4065) e le tipologie di installazione indicate nel presente manuale.

Nelle sezioni che seguono le formule adottate tengono conto dei seguenti criteri:

- le ante ed i vetri vengono realizzati con le stesse dimensioni (LM=LF, HM=HF);
- il vano passaggio massimo PLmax viene considerato tra i montanti verticali delle ante fisse e/o della cornice. Il vano passaggio utile potrebbe ridursi di circa 20÷40 mm;
- per ogni tipologia di porta viene indicata la dimensione minima dell'automazione LT.



PAM23 SERIES PROFILES

The tests carried out in the laboratory and onsite indicate a maximum load of the door wing of 120 kg.

For a more precise structural check, verify the moments of inertia for load-bearing profiles (drawings no. 4064 and 4065) and the types of installation indicated in this manual.

In the sections below, the formulas used take into account the following criteria:

- the door wings and windowpanes are produced in the same dimensions (LM=LF, HM=HF);
- the PLmax maximum door width is considered to be between the vertical jambs of the fixed doors and/or the frame. The usable door width may be reduced to approximately 20-40 mm;
- for every type of door, the minimum dimension of the LT automation is indicated.



PROFILES SERIE PAM23

Les essais effectués en laboratoire et sur place conduisent à une portée maximale du vantail de 120 kg.

Pour un contrôle plus minutieux de la structure, contrôler les moments d'inertie pour profilés porteurs (dessins 4064 et 4065) et les typologies d'installation indiquées dans ce manuel.

Les formules adoptées dans les sections suivantes tiennent compte des critères suivants :

- les mesures des vantaux et des vitres sont les mêmes (LM=LF, HM=HF) ;
- la baie de passage maximum PLmax est considérée entre les montants verticaux des vantaux fixes et/ou du cadre. La baie de passage utile pourrait être réduite d'environ 20÷40 mm;
- pour chaque typologie de porte la dimension minimale de l'automatisme LT est indiquée.



PROFILE BAUREIHE PAM23

Die im Labor und vor Ort durchgeführten Tests ergeben eine maximale Tragfähigkeit des Flügels von 120 kg.

Für eine genauere Strukturprüfung die Trägheitsmomente für tragende Profile (Zei. Nr. 4064 und 4065) und die in diesem Handbuch angegebenen Installationsarten prüfen.

Die in den folgenden Abschnitten angewandten Formeln beziehen sich auf die folgenden Kriterien:

- die Flügel und die Scheiben werden mit den gleichen Abmessungen (LM=LF, HM=HF) ausgeführt;
- als maximale Durchgangsöffnung P_{max} wird der Abstand zwischen den vertikalen Trägern der Seitenteile und/oder des Rahmens betrachtet. Die nutzbare Durchgangsöffnung kann circa 20÷40 mm schmaler sein;
- für jede Türart wird die minimale Abmessung des Antriebs LT angegeben.



PERFILES SERIE PAM23

Las pruebas efectuadas en el laboratorio y en el lugar de funcionamiento indican una capacidad máxima de la hoja de 120 Kg.

Para un control estructural más cuidadoso, compruebe los momentos de inercia para perfiles portantes (dib. n. 4064 y 4065) y los tipos de instalación indicados en este manual.

En las secciones que siguen, las fórmulas adoptadas tienen en cuenta los siguientes criterios:

- las hojas y los cristales se realizan con las mismas dimensiones (LM=LF, HM=HF);
- el espacio de paso máximo P_{max} es considerado entre los montantes verticales de las hojas fijas y/o del marco. El espacio de paso útil podría reducirse aproximadamente unos 20÷40 mm;
- para cada tipo de puerta se indica la dimensión mínima del automatismo LT.



PERFIS DA SÉRIE PAM23

Os testes efectuados em laboratório e os ensaios de campo indicaram uma alcance máxima da portinhola de 120 kg.

Para verificar a estrutura de forma mais exacta, controlar os momentos de inércia para perfis estruturais (desenhos nº 4064 e nº 4065) e os tipos de instalação indicadas no presente manual.

Nas secções abaixo, as fórmulas tomam conta dos critérios seguintes:

- as portinholas e os vidros são realizados com as mesmas dimensões (LM=LF, HM=HF);
- o vão de passagem máximo P_{max} é considerado entre os montantes verticais das portinholas fixas e/ou do caixilho. O vão de passagem útil poderá reduzir-se em cerca de 20÷40 mm;
- por cada tipo de porta é indicada a dimensão mínima do automatismo LT.

4065
1,243 kg/m

$X_g = 11,5 \text{ mm}$
 $Y_g = 40 \text{ mm}$
 $L_{xx} = 210826 \text{ mm}^4$
 $L_{yy} = 39567 \text{ mm}^4$

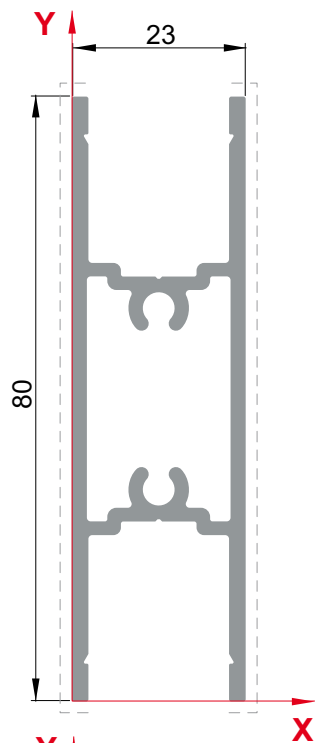

4084
1,012 kg/m

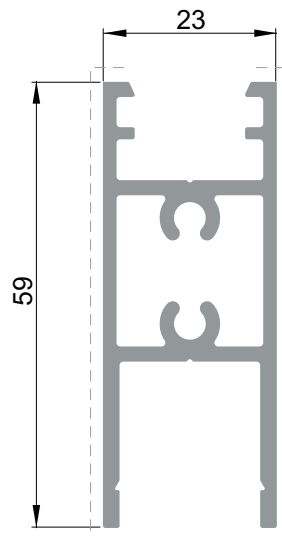

4064
1,109 kg/m

$X_g = 11,5 \text{ mm}$
 $Y_g = 35,9594 \text{ mm}$
 $L_{xx} = 145683 \text{ mm}^4$
 $L_{yy} = 33618 \text{ mm}^4$

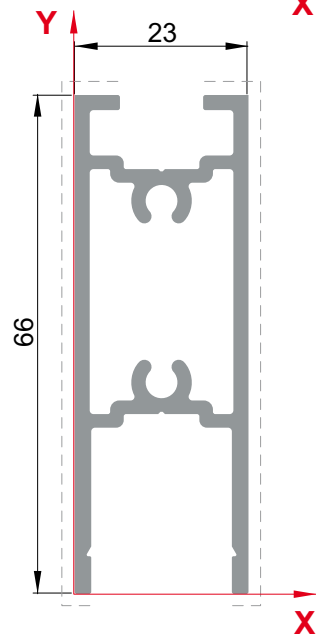

4066
0,385 kg/m

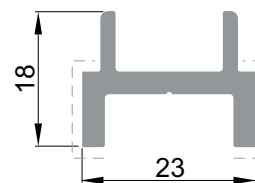

4072
0,294 kg/m

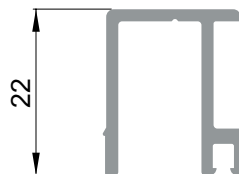

4067
0,599 kg/m

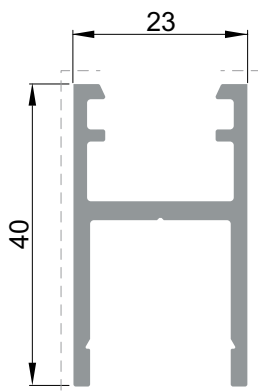

4068
0,526 kg/m

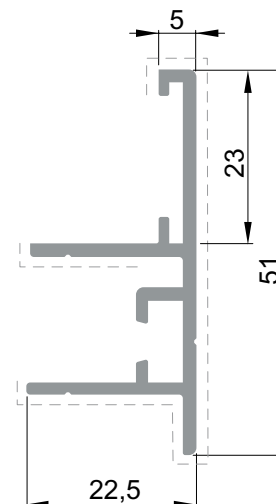

4085
2,112 kg/m

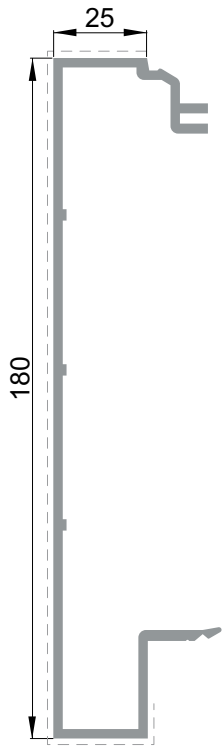

4063
2,720 kg/m

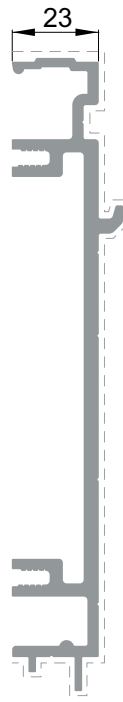

4074
1,248 kg/m

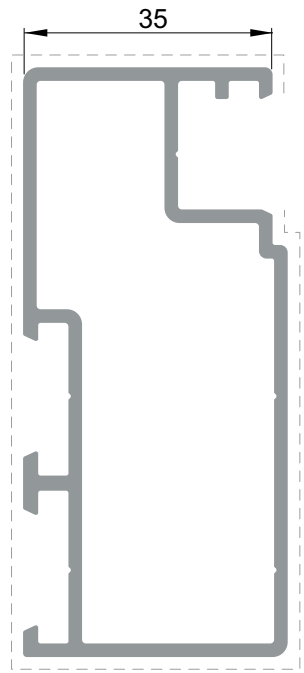

4069
0,623 kg/m

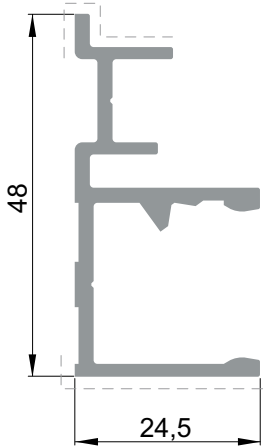

4070
0,486 kg/m

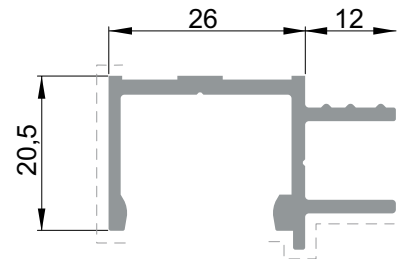

4073
0,686 kg/m

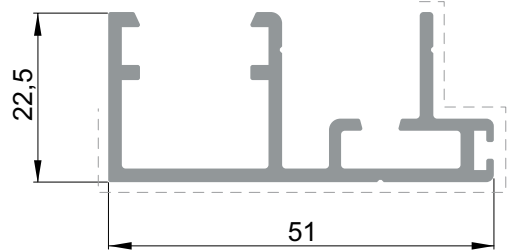

4071
0,507 kg/m

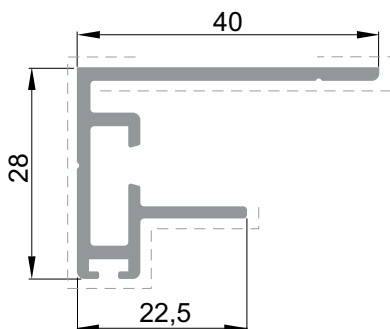

P598
0,137 kg/m

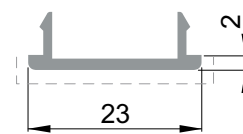

KT4063

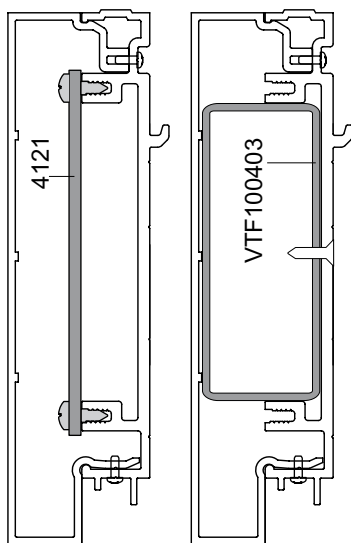
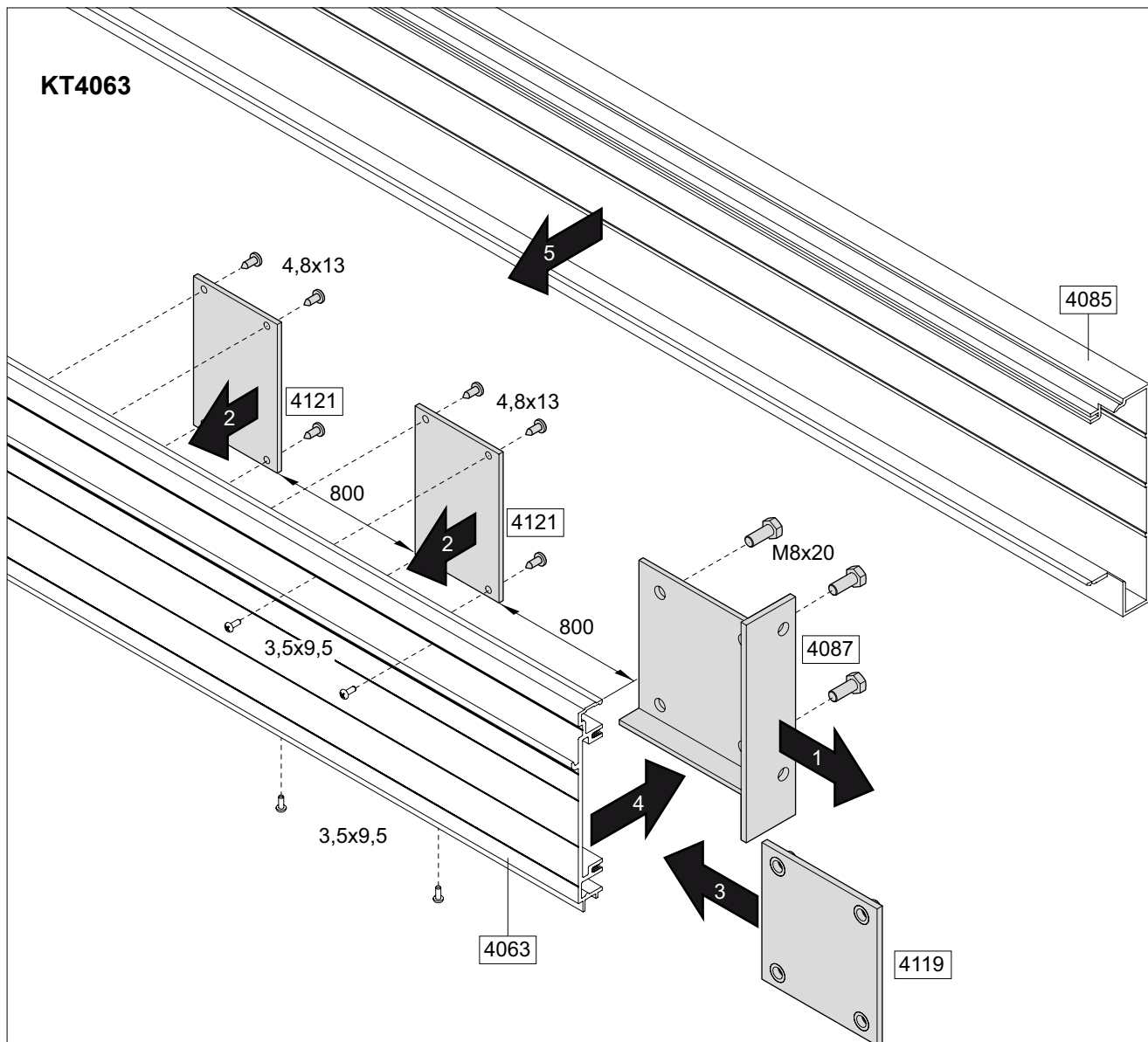

1. Fissare la staffa 4087 a parete, in modo robusto mediante viti non di nostra fornitura.
2. Fissare le piastre 4121 alla trave 4063 ogni 800 mm circa, mediante le viti 4,8x13. Oppure fissare il tubolare VTF100403 mediante viti non di nostra fornitura (vedi pag. 11 e 18).
3. Inserire la staffa 4119 nella trave 4063.
4. Fissare la trave 4063 alla staffa 4087, mediante le viti M8x20.
5. Fissare il profilo 4085 alla trave 4063, mediante le viti 3,5x9,5.

1. Fasten bracket 4087 securely to the wall with screws (not supplied).
2. Fasten the plates 4121 to beam 4063 approximately every 800 mm using the 4.8x13 screws. Otherwise, fasten tube VTF100403 with screws (not supplied – see page 11 and 18).
3. Insert bracket 4119 in beam 4063.
4. Fasten beam 4063 to bracket 4087 using the M8x20 screws.
5. Fasten profile 4085 to beam 4063 using the 3.5x9.5 screws.

KC23

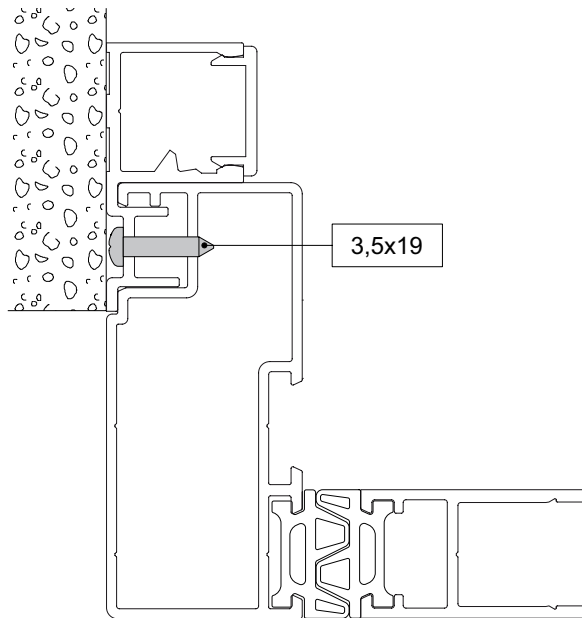
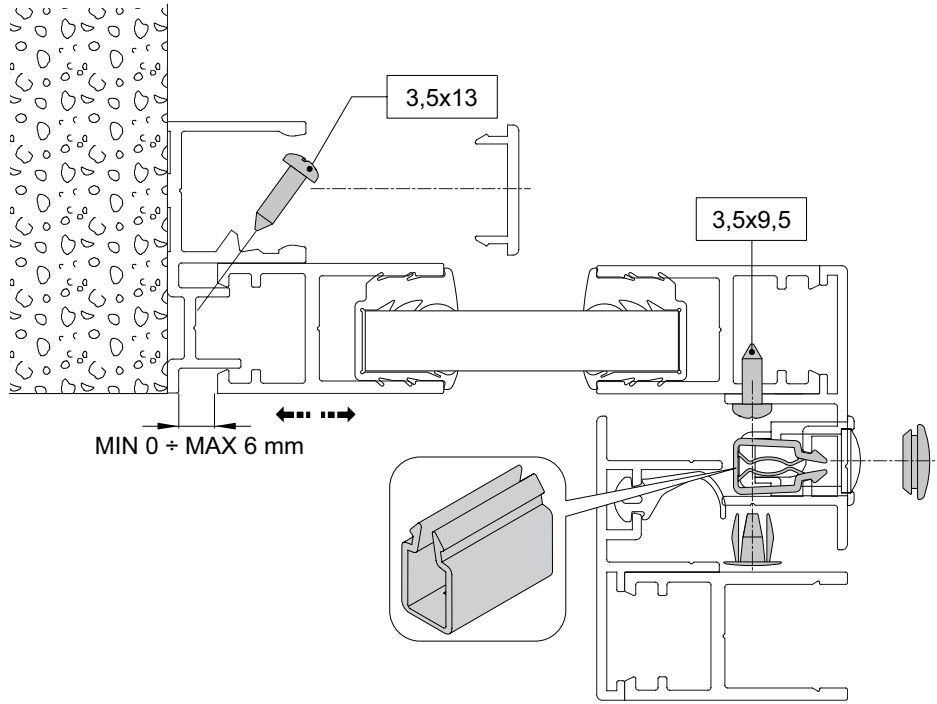

KAF23

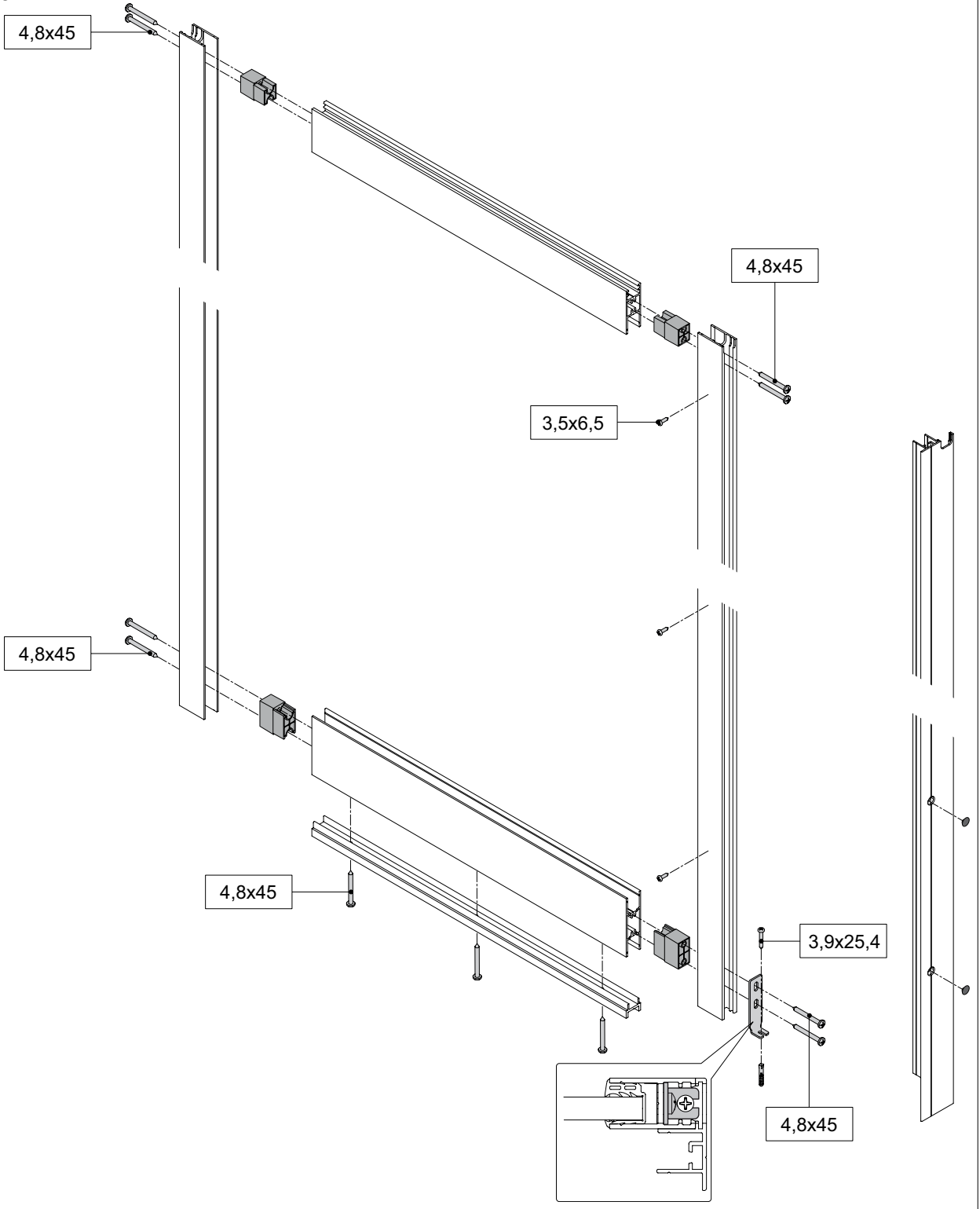

KPAM45

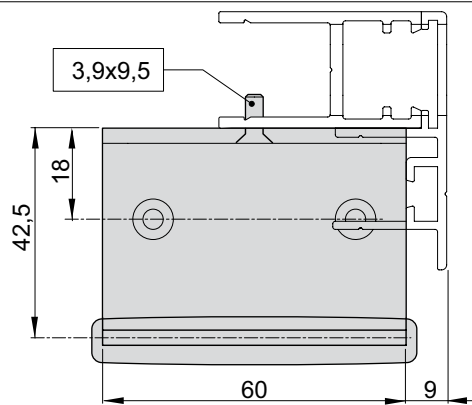

KAM23

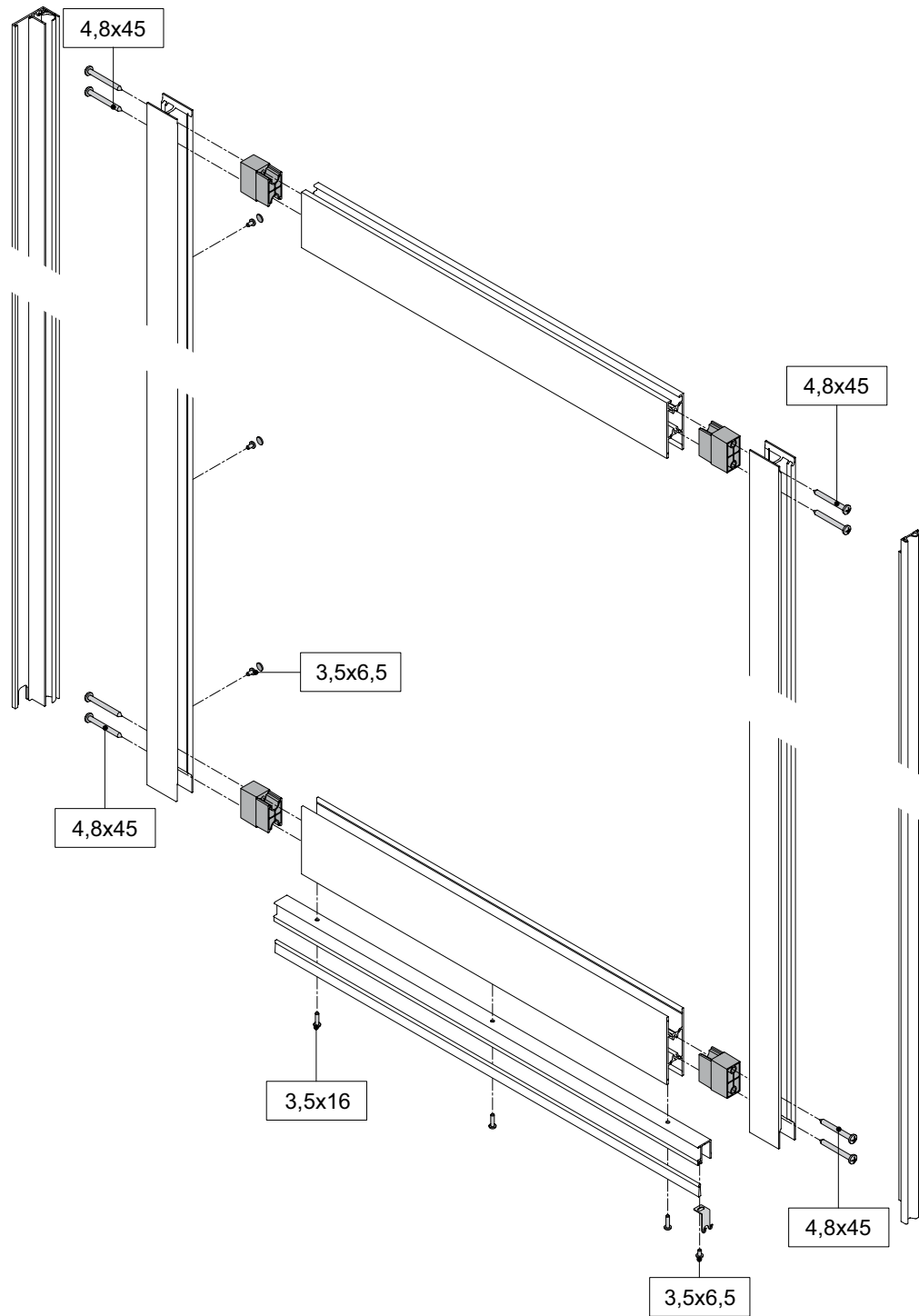

KEV23

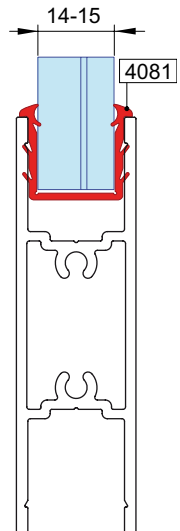
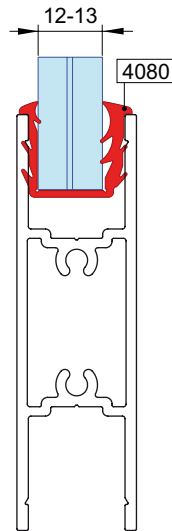
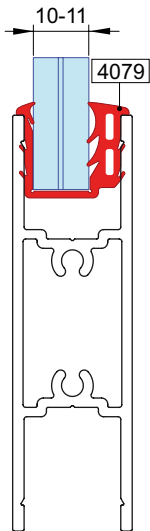
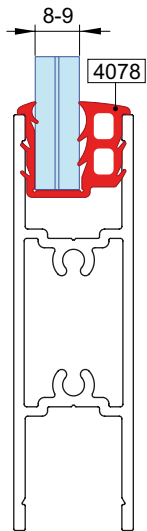
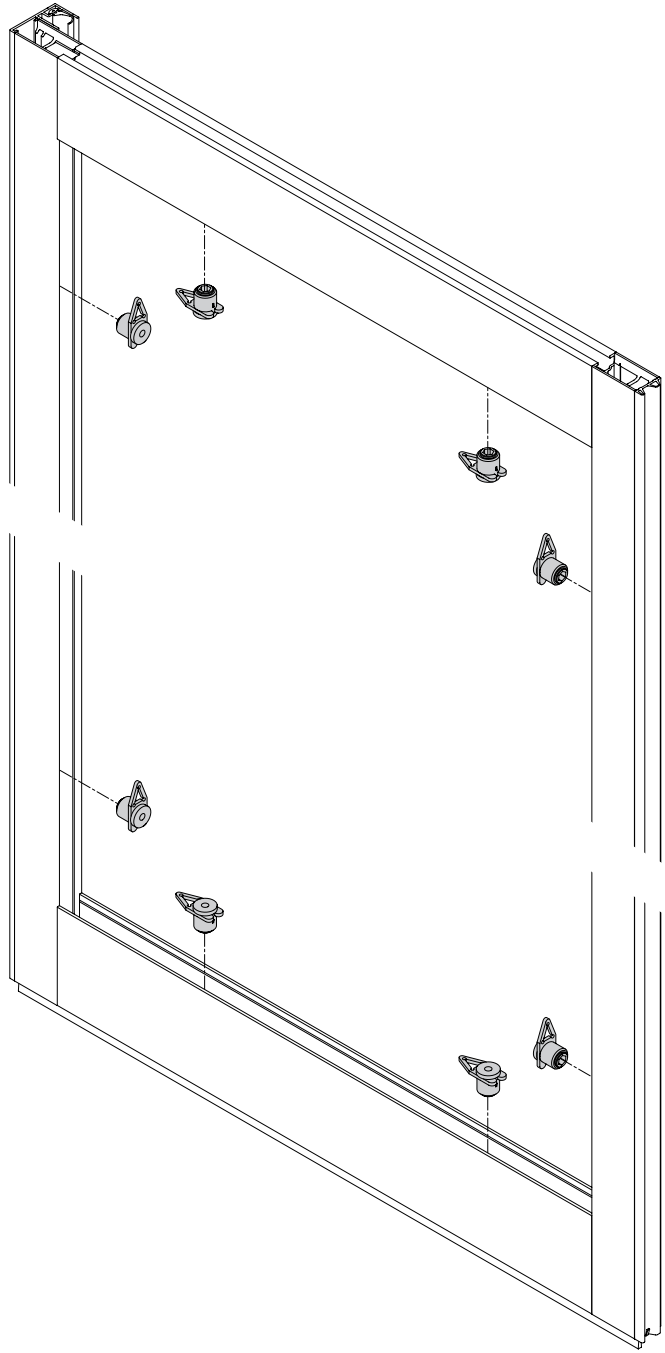
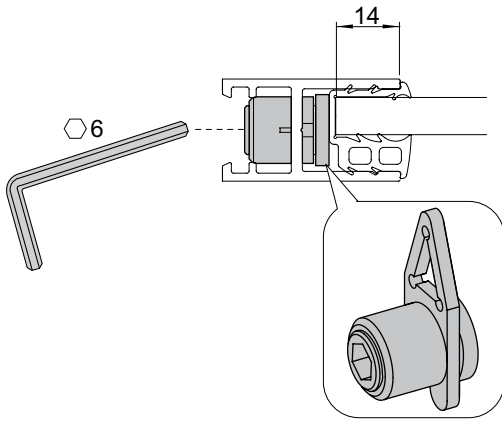

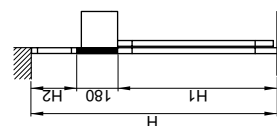
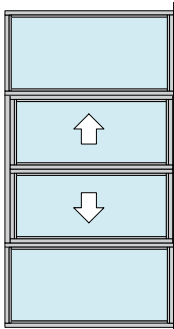
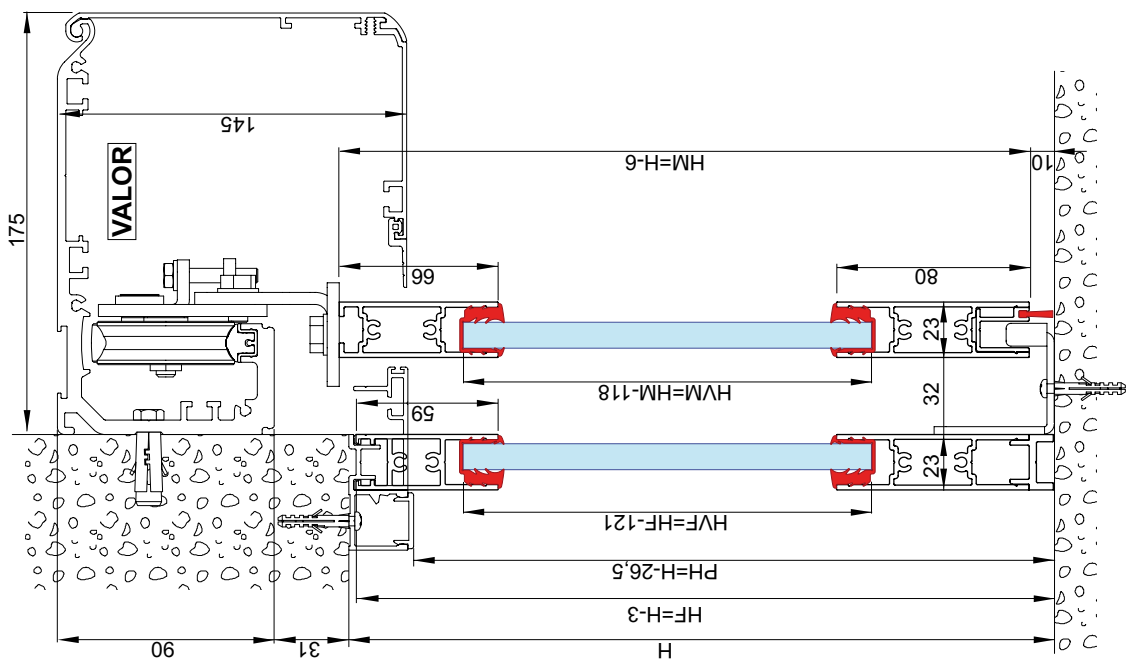
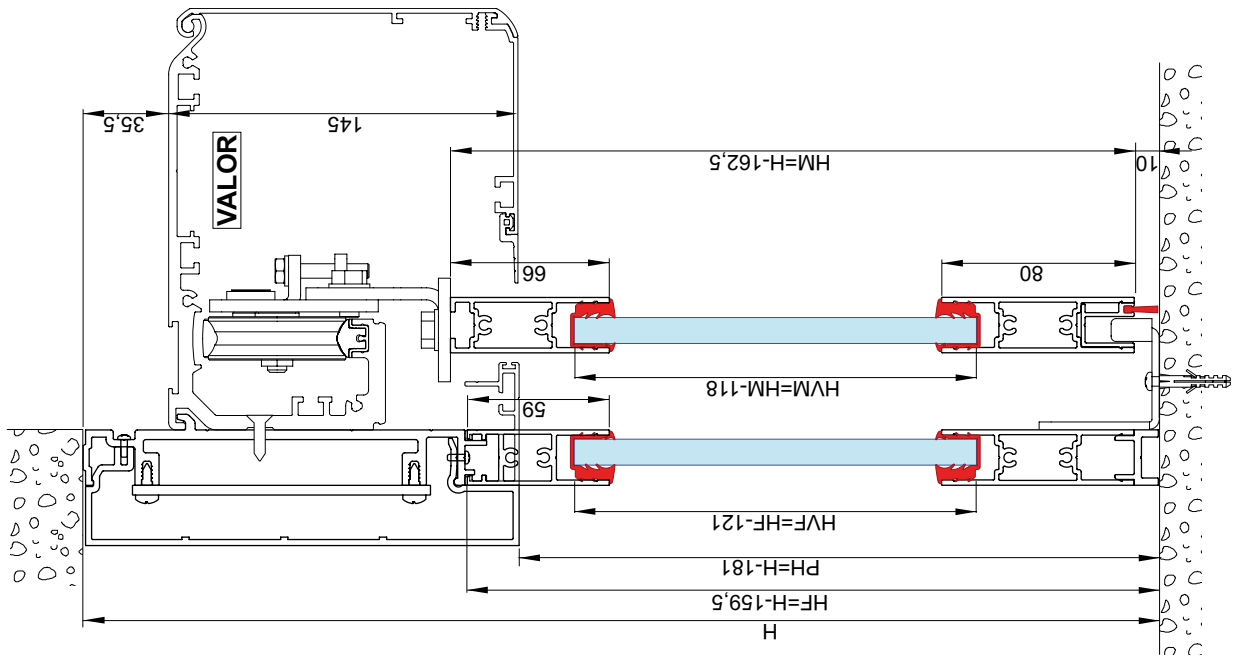

$PH = H1$
 $HM = H1 + 18,5$
 $HF = H1 + 21,5$
 Se il serramento
 comprende sopralluce,
 consultare il manuale
 IP2049.
 If the door frame has
 the fanlight, see the
 IP2049 manual.

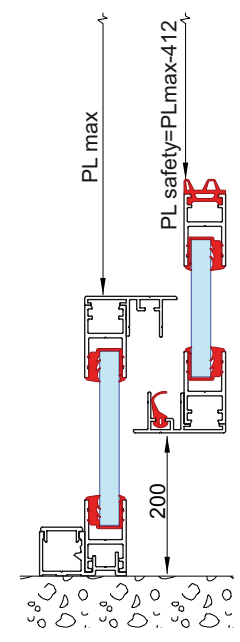
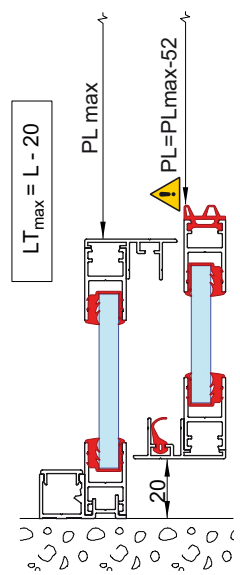
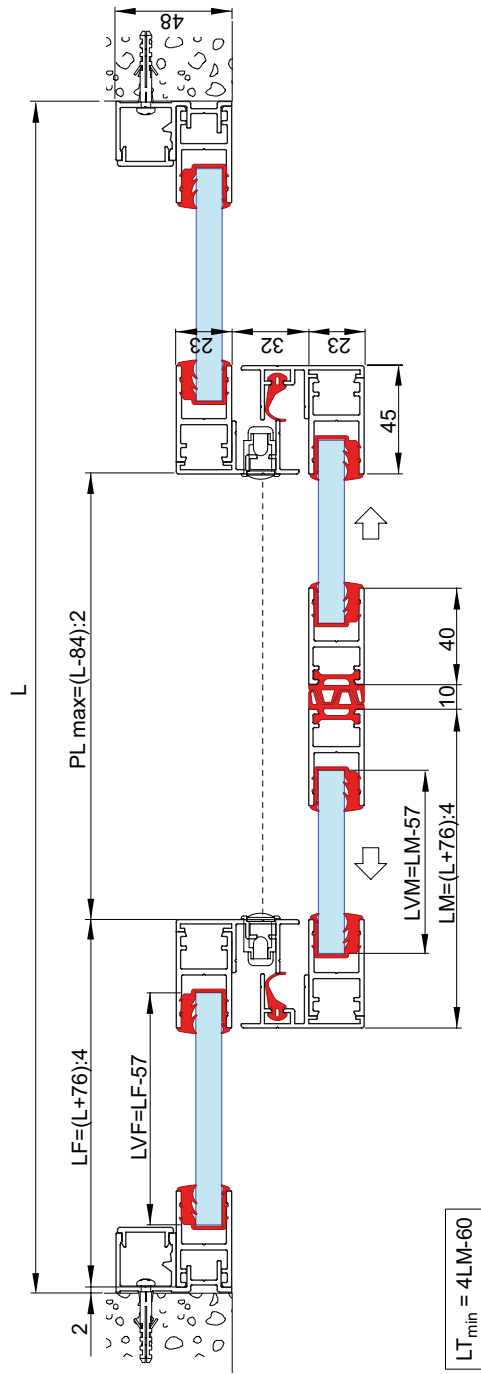
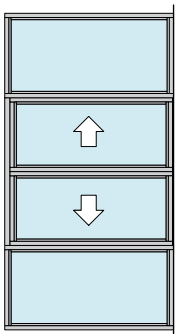

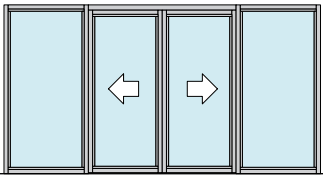

Cornice / Frame

senza trave without beam		4069	L - 49	1x
		P598	H	2x
		4073	L - 84) : 2	1x
	Kit	KC23	-	1x
con trave with beam		4069	H - 181	2x
		P598	H - 181	2x
		4085	L - 10	1x
		4063	L - 10	1x
		4073	(L - 84) : 2	1x
	Kit	KC23	-	1x
	Kit	KT4063	-	1x
	VTF100403	L - 255	1x	

Serramento senza sopra luce.

Fissare la trave al soffitto, mediante viti non di nostra fornitura, oppure usare il rinforzo trave VTF100403, nell'area colorata.

Door frame without fanlight.

Fix the beam to ceiling through screws not supplied by us, or use the VTF100403 beam stiffening, in the coloured area.

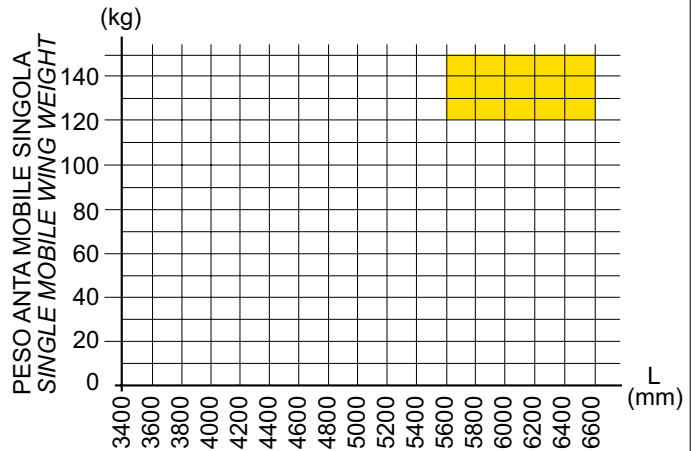

Serramento con sopra luce (max 200 kg).

Usare il rinforzo trave VTF100403 nell'area colorata.

Door frame with fanlight (max 200 kg).

Use the VTF100403 beam stiffening in the coloured area.

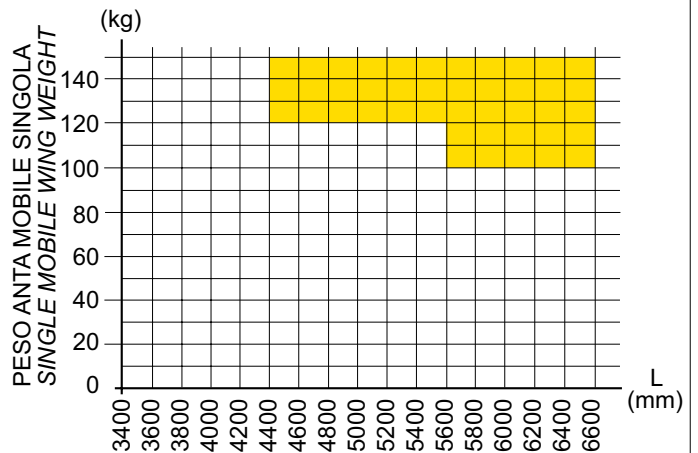

Serramento con sopra luce (da 200 a 350 kg).

Usare il rinforzo trave VTF100403 nell'area colorata.

Door frame with fanlight (from 200 to 350 kg).

Use the VTF100403 beam stiffening in the coloured area.

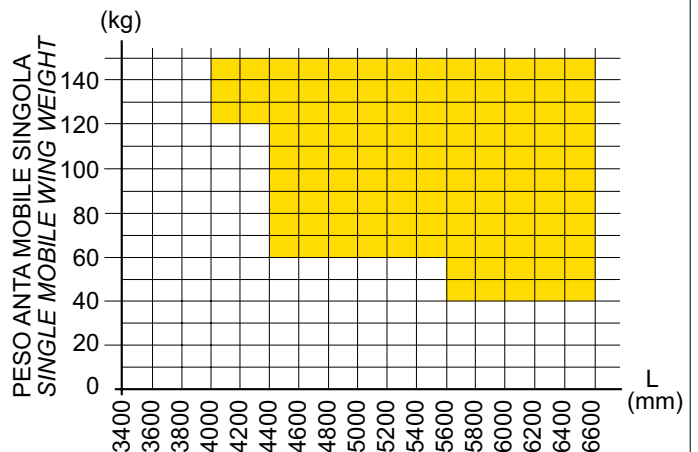

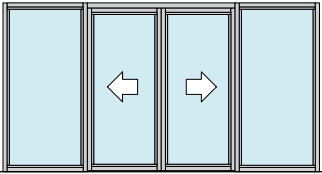

Anta fissa / Fixed door wing				
		4065	LF - 85	2x
		4084	LF - 85	2x
		4066	LF - 85	2x
		4067	HF	4x
		4068	HF	2x
vetro/glass 8-9 mm		4078	LF - 85	4x
			HF - 121	4x
vetro/glass 10-11 mm		4079	LF - 85	4x
			HF - 121	4x
vetro/glass 12-13 mm		4080	LF - 85	4x
			HF - 121	4x
vetro/glass 14-15 mm		4081	LF - 85	4x
			HF - 121	4x
Kit		KAF23	-	2x
Kit		KEV23	-	2x

Anta mobile / Moving door wing				
		4065	LM - 85	2x
		4064	LM - 85	2x
		4072	LM - 6	2x
		SPAZ14	LM - 6	2x
		4067	HM	4x
		4068	HM	2x
		3838	HM	2x
		4077	HM	2x
vetro/glass 8-9 mm		4078	LM - 85	4x
			HM - 118	4x
vetro/glass 10-11 mm		4079	LM - 85	4x
			HM - 118	4x
vetro/glass 12-13 mm		4080	LM - 85	4x
			HM - 118	4x
vetro/glass 14-15 mm		4081	LM - 85	4x
			HM - 118	4x
Kit		KAM23	-	2x
Kit		KEV23	-	2x
Kit		KPAM45	-	2x

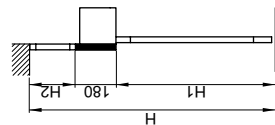
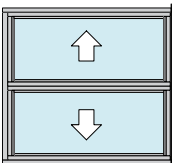
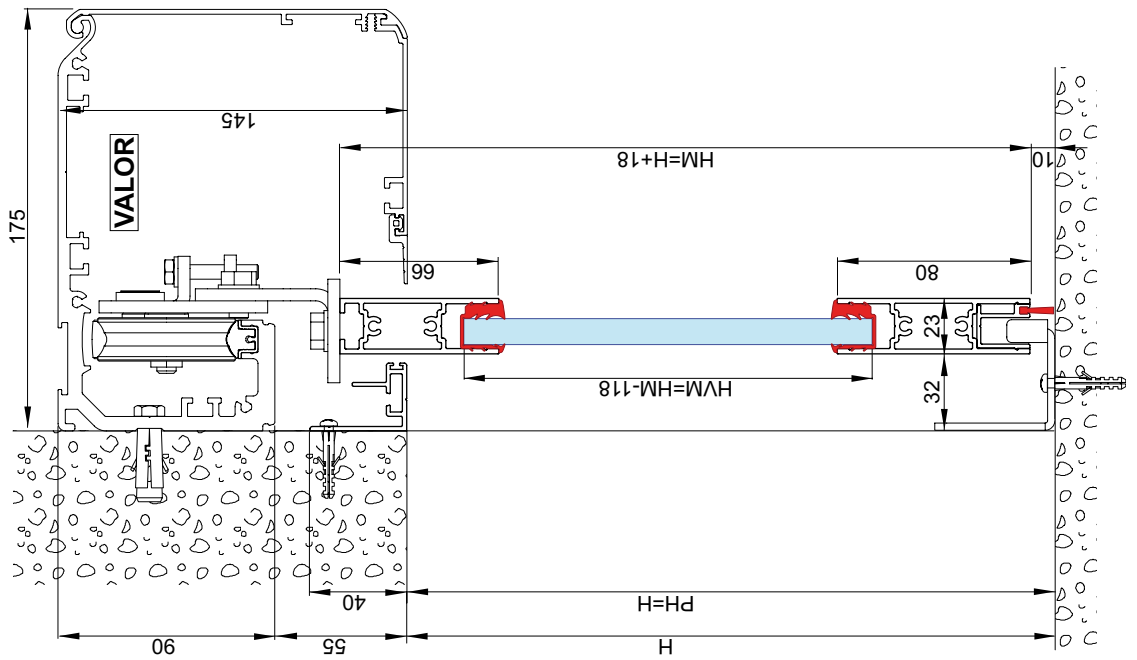
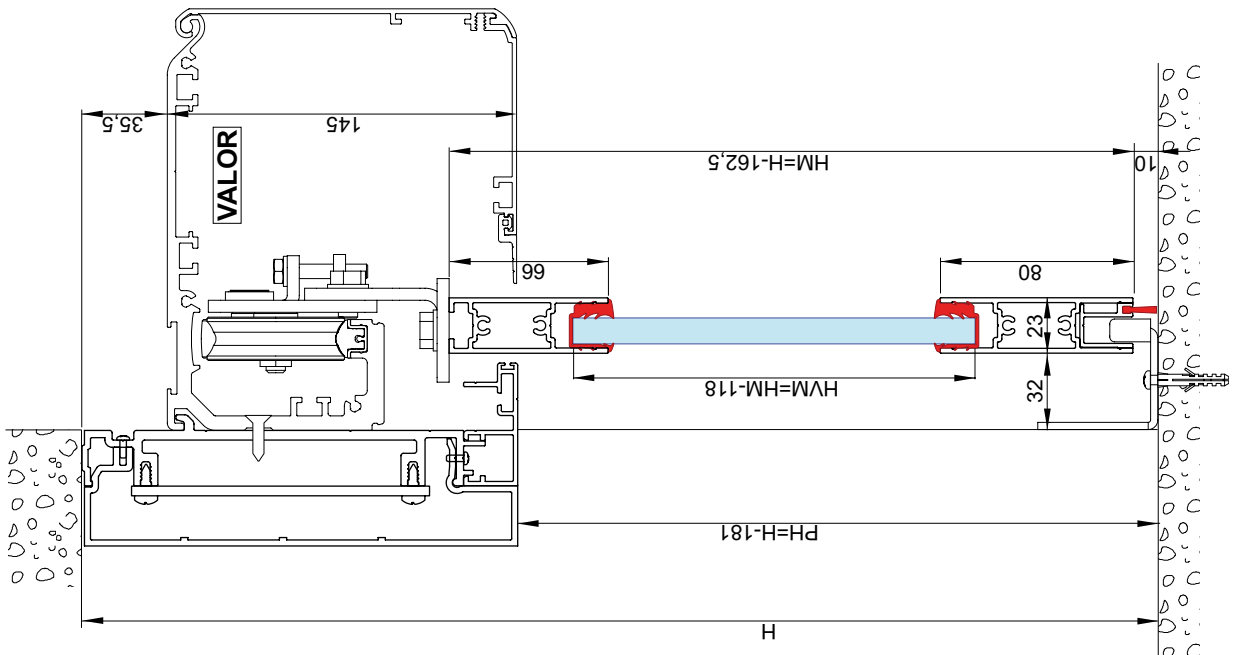

PH = H1
 HM = H1 + 18,5

Se il serramento
 comprende sopra-
 luce, consultare il manuale
 IP2049.

If the door frame has
 the fanlight, see the
 IP2049 manual.

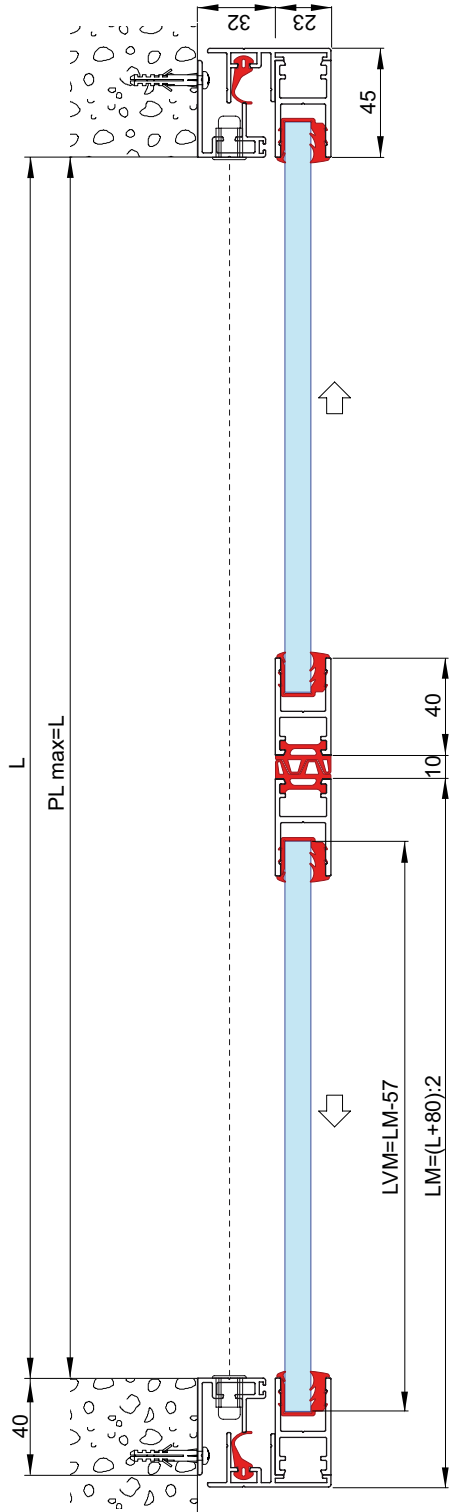
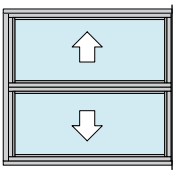

$LT_{min} = 4LM - 60$



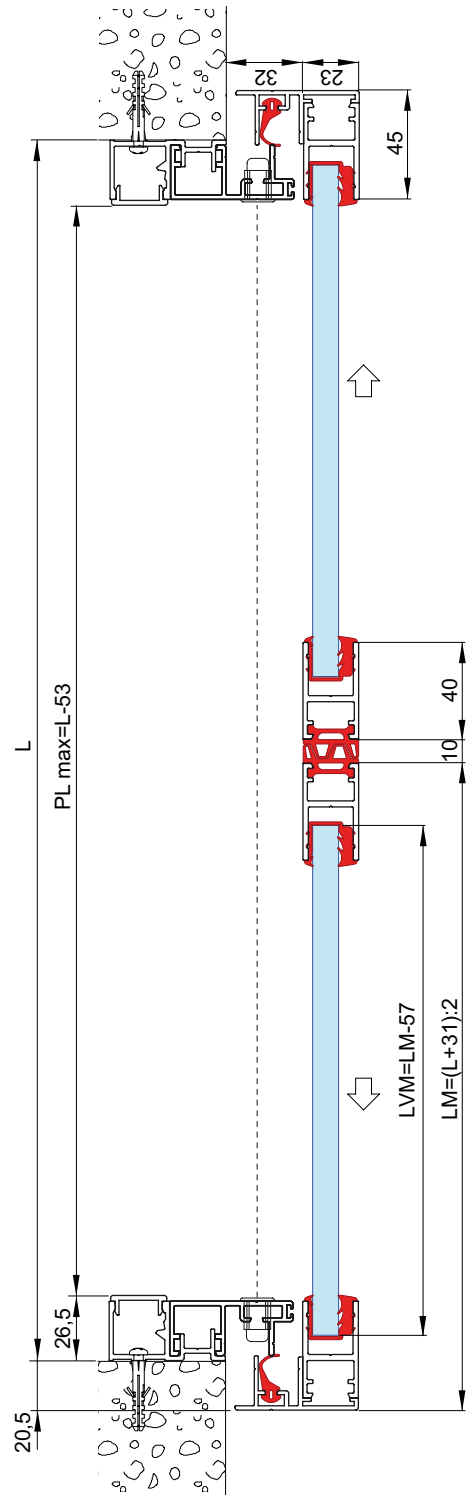



!
 senza trave
 without beam

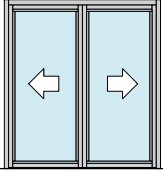





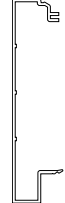



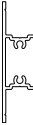



$LT_{min} = 4LM - 60$

!
 con trave
 with beam



Cornice / Frame				
senza trave without beam		4071	L	1x
			H + 55	2x
	Kit	KC23	-	1x
con trave with beam		4069	H - 181	2x
		P598	H - 181	2x
		4073	L - 49	1x
			H - 158,5	2x
		4085	L - 10	1x
		4063	L - 10	1x
	Kit	KC23	-	1x
Kit	KT4063	-	1x	

Anta mobile / Moving door wing				
		4065	LM - 85	2x
		4064	LM - 85	2x
		4072	LM - 6	2x
		SPAZ14	LM - 6	2x
		4067	HM	4x
		4068	HM	2x
		3838	HM	2x
		4077	HM	2x
vetro/glass 8-9 mm		4078	LM - 85	4x
			HM - 118	4x
vetro/glass 10-11 mm		4079	LM - 85	4x
			HM - 118	4x
vetro/glass 12-13 mm		4080	LM - 85	4x
			HM - 118	4x
vetro/glass 14-15 mm		4081	LM - 85	4x
			HM - 118	4x
Kit	KAM23	-	2x	
Kit	KEV23	-	2x	
Kit	KPAM45	-	2x	

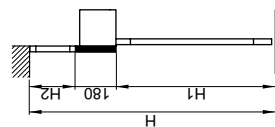
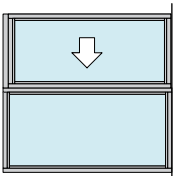
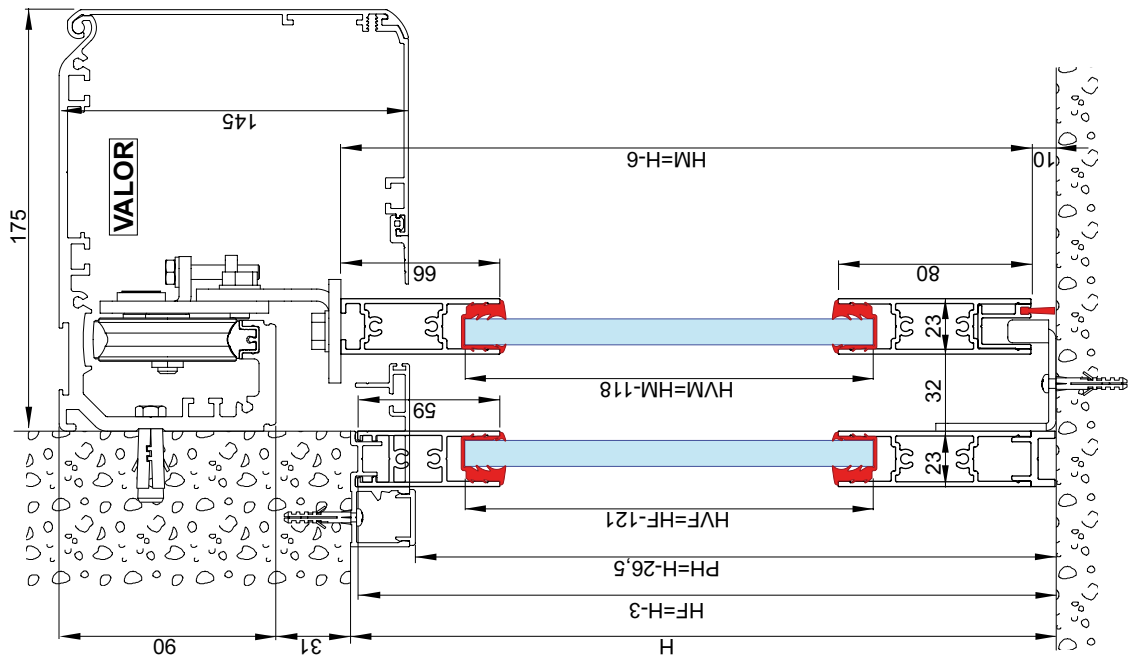
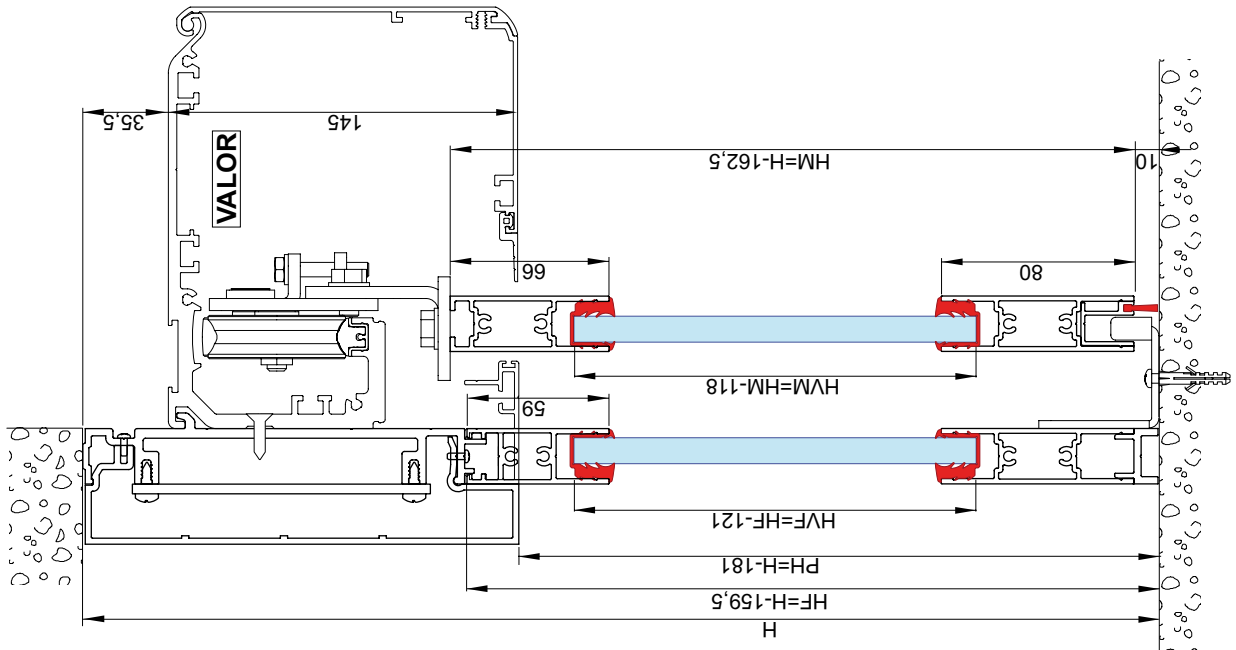

$PH = H1$
 $HM = H1 + 18,5$
 $HF = H1 + 21,5$

Se il serramento
 comprende soprauce,
 consultare il manuale
 IP2049.
 If the door frame has
 the fanlight, see the
 IP2049 manual.

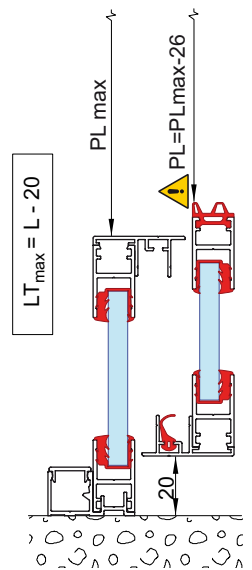
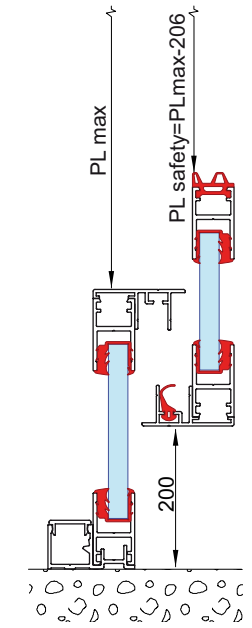
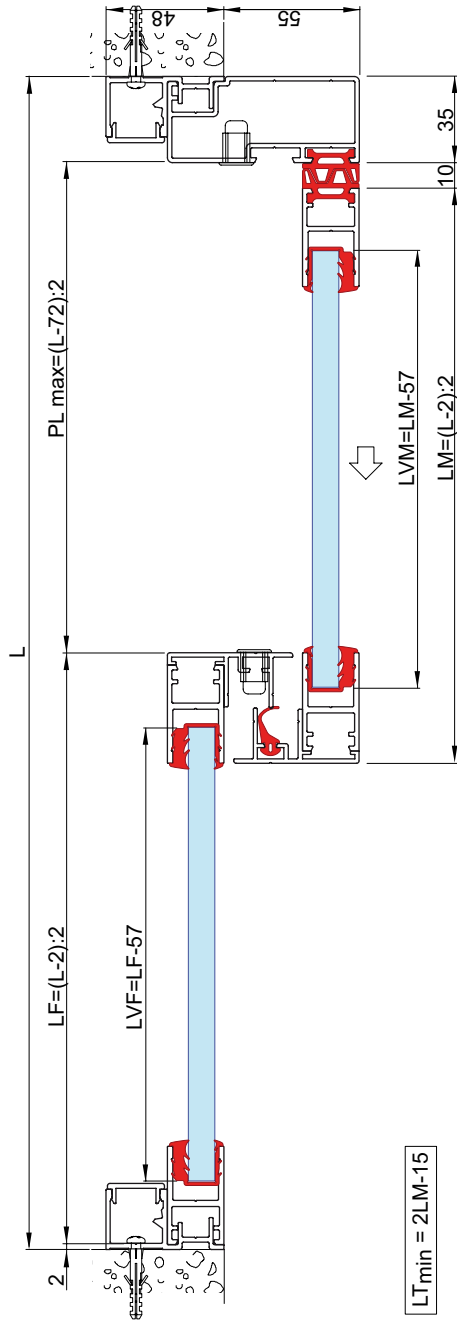
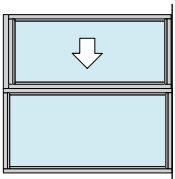

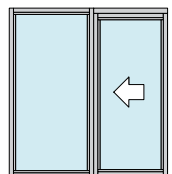

Cornice / Frame				
senza trave without beam		4069	L - 49	1x
			H	2x
		P598	L - 49	1x
			H - 27	2x
		4074	H - 2	1x
		4077	H - 2	1x
		4073	(L - 72) : 2	1x
Kit	KC23	-	1x	

con trave with beam		4069	H - 181	2x
		P598	H - 181	2x
		4074	H - 158,5	1x
		4077	H - 158,5	1x
		4085	L - 10	1x
		4063	L - 10	1x
		4073	(L - 72) : 2	1x
	Kit	KC23	-	1x
	Kit	KT4063	-	1x

Anta fissa / Fixed door wing				
	4065	LF - 85	1x	
	4084	LF - 85	1x	
	4066	LF - 85	1x	
	4067	HF	2x	
	4068	HF	1x	
vetro/glass 8-9 mm		4078	LF - 85	2x
			HF - 121	2x
vetro/glass 10-11 mm		4079	LF - 85	2x
			HF - 121	2x
vetro/glass 12-13 mm		4080	LF - 85	2x
			HF - 121	2x
vetro/glass 14-15 mm		4081	LF - 85	2x
			HF - 121	2x
Kit	KAF23	-	1x	
Kit	KEV23	-	1x	

Anta mobile / Moving door wing				
	4065	LM - 85	1x	
	4064	LM - 85	1x	
	4072	LM - 6	1x	
	SPAZ14	LM - 6	1x	
	4067	HM	1x	
	4068	HM	1x	
	3838	HM	1x	
	4077	HM	1x	
vetro/glass 8-9 mm		4078	LM - 85	2x
			HM - 118	2x
vetro/glass 10-11 mm		4079	LM - 85	2x
			HM - 118	2x
vetro/glass 12-13 mm		4080	LM - 85	2x
			HM - 118	2x
vetro/glass 14-15 mm		4081	LM - 85	2x
			HM - 118	2x
Kit	KAM23	-	1x	
Kit	KEV23	-	1x	
Kit	KPAM45	-	1x	

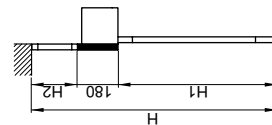
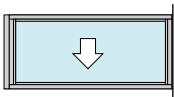
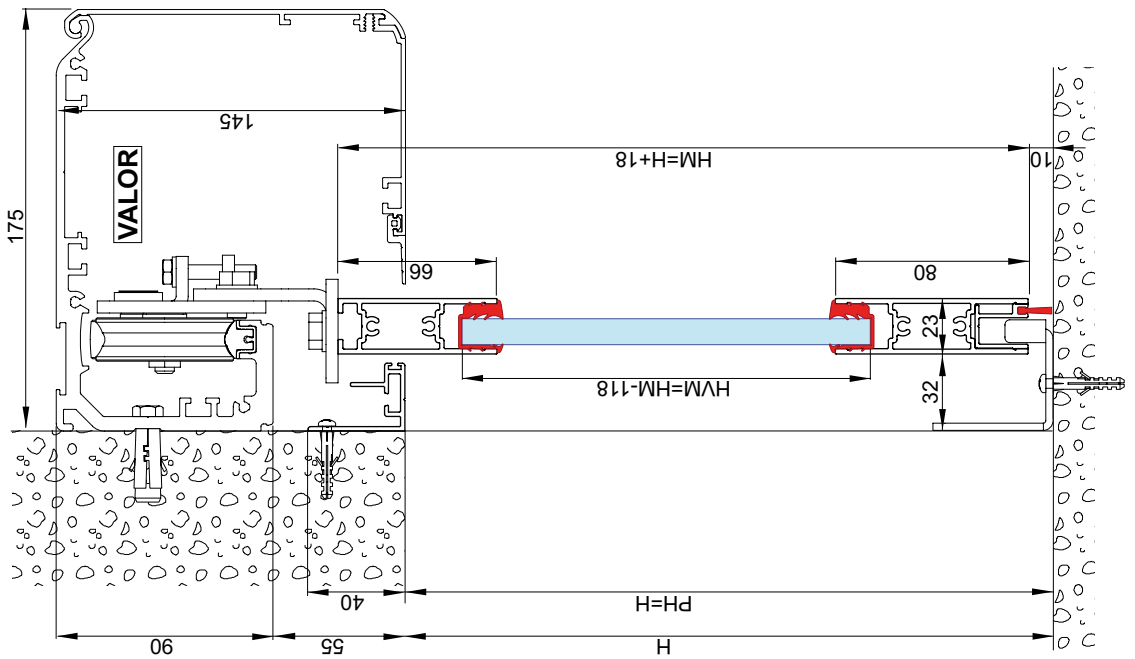
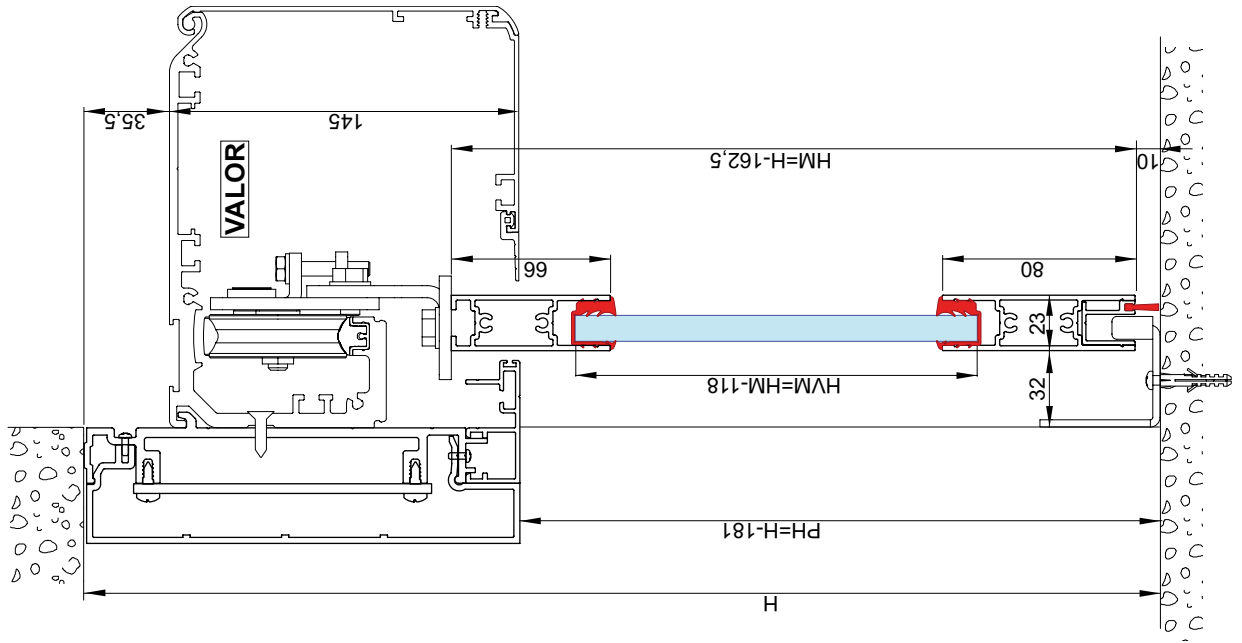

PH = H1
 HM = H1 + 18.5



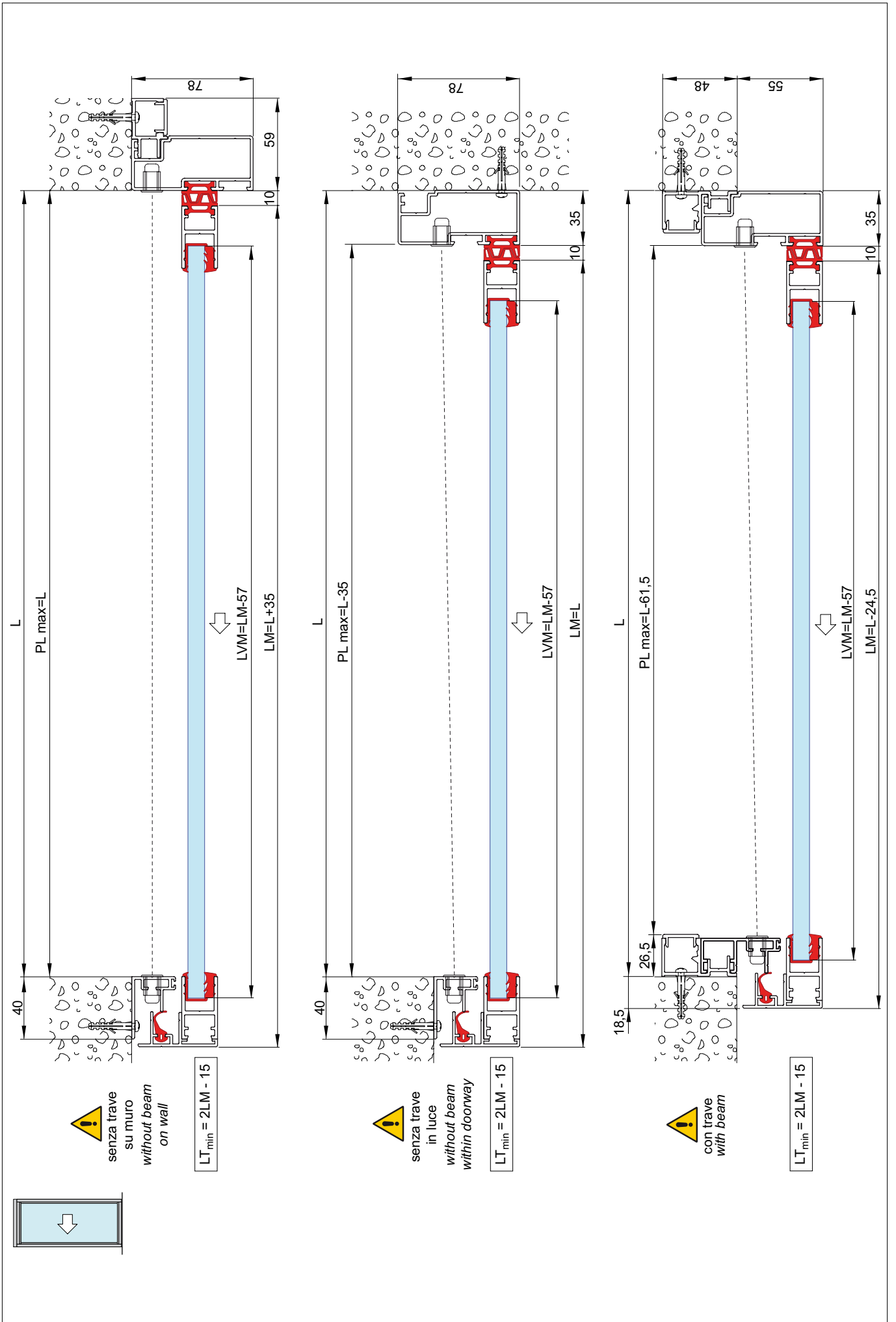

Se il serramento
 comprende sopra-
 luce, consultare il manuale
 IP2049.

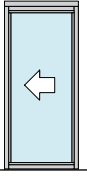

If the door frame has
 the fanlight, see the
 IP2049 manual.

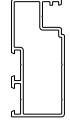





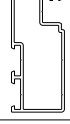





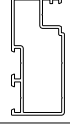

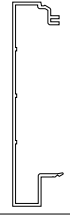
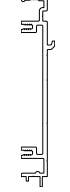

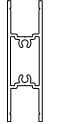
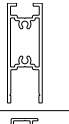

Cornice / Frame

senza trave su muro <i>without beam on wall</i>		4071	L	1x
			H + 55	1x
		4074	H + 55	1x
			H + 55	1x
		4070	H + 55	1x
		P598	H + 55	1x
Kit	KC23	-	1x	

senza trave in luce <i>without beam within doorway</i>		4071	L - 35	1x
			H + 55	1x
		4074	H + 55	1x
			H + 55	1x
	Kit	KC23	-	1x

con trave <i>with beam</i>		4069	H - 181	2x
		P598	H - 181	2x
		4073	L - 59,5	1x
			H - 158,5	1x
		4074	H - 158,5	1x
			H - 158,5	1x
		4085	L - 10	1x
			L - 10	1x
	Kit	KC23	-	1x
	Kit	KT4063	-	1x

Anta mobile / Moving door wing

	4065	LM - 85	1x	
				
	4072	LM - 6	1x	
	SPAZ14	LM - 6	1x	
	4067	HM	2x	
	4068	HM	1x	
	3838	HM	1x	
	4077	HM	1x	
vetro/glass 8-9 mm		4078	LM - 85	2x
		HM - 118	2x	
vetro/glass 10-11 mm		4079	LM - 85	2x
		HM - 118	2x	
vetro/glass 12-13 mm		4080	LM - 85	2x
		HM - 118	2x	
vetro/glass 14-15 mm		4081	LM - 85	2x
		HM - 118	2x	
Kit	KAM23	-	1x	
Kit	KEV23	-	1x	
Kit	KPAM45	-	1x	

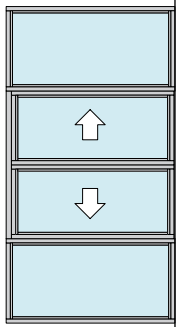

Vedi sezione orizzontale pag. 10
 Vedi distinta di taglio pag. 11 modificata come segue.
 See horizontal section pag. 10.
 See cutting list pag. 11 as modified below.

con trave with beam		4067	L - 10	1x
		4069	H - 220	2x
		P598	H - 220	2x

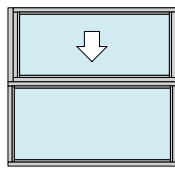

Vedi sezione orizzontale pag. 17
 Vedi distinta di taglio pag. 18 modificata come segue.
 See horizontal section pag. 17.
 See cutting list pag. 18 as modified below.

con trave with beam		4067	L - 10	1x
		4069	H - 220	2x
		P598	H - 220	2x
		4074	H - 197,5	1x
		4077	H - 197,5	1x

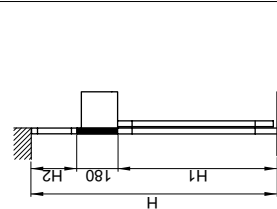
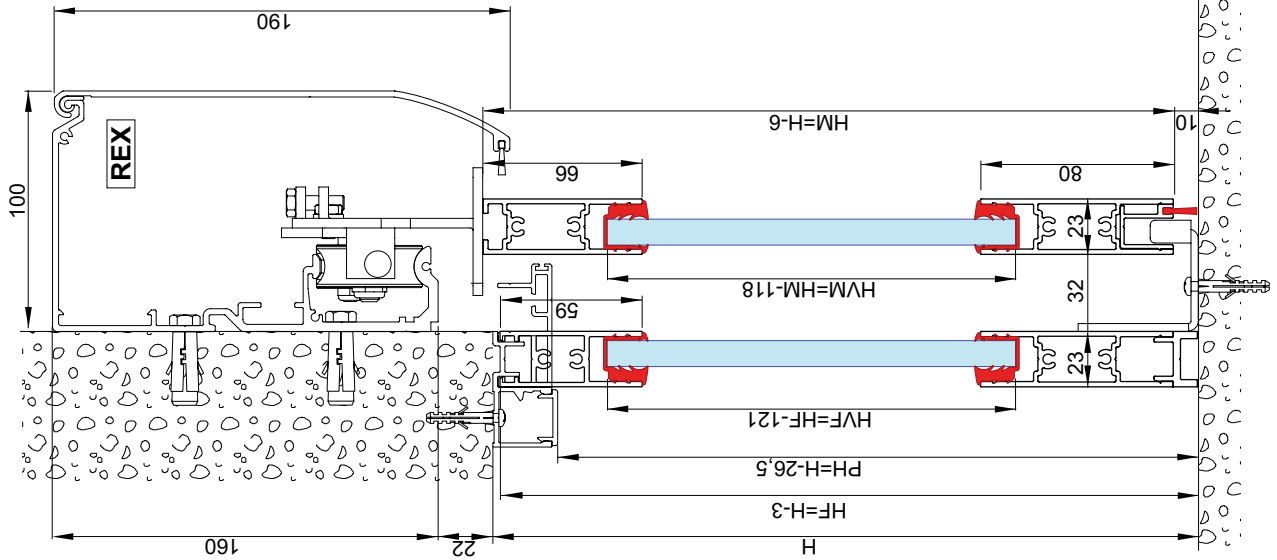

PH = H1
 HM = H1 + 18,5
 HF = H1 + 21,5
 Se il serramento
 comprende sopra-luce,
 consultare il manuale
 IP2049.
 If the door frame has
 the fanlight, see the
 IP2049 manual.

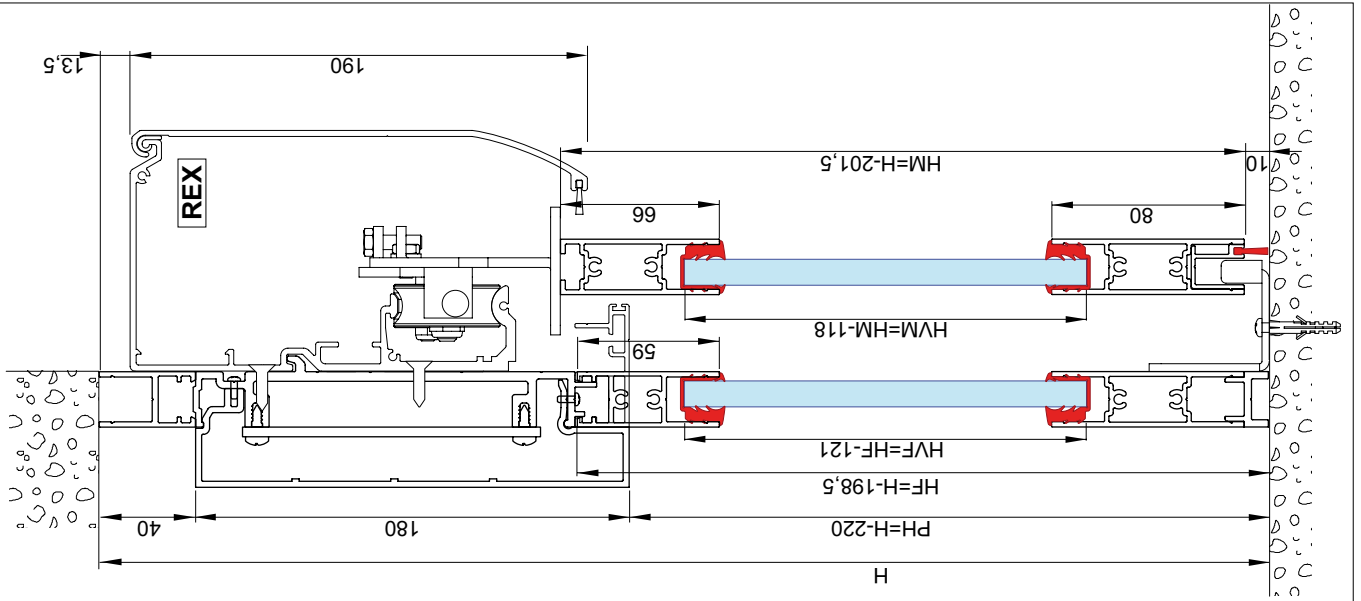

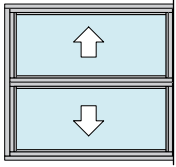

Vedi sezione orizzontale pag. 14
 Vedi distinta di taglio pag. 15 modificata come segue.
 See horizontal section pag. 14.
 See cutting list pag. 15 as modified below.

con trave		4067	L - 10	1x
		4069	H - 220	2x
		P598	H - 220	2x
		4073	H - 197,5	2x

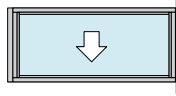

Vedi sezione orizzontale pag. 20
 Vedi distinta di taglio pag. 21 modificata come segue.
 See horizontal section pag. 20.
 See cutting list pag. 21 as modified below.

con trave		4067	L - 10	1x
		4069	H - 220	2x
		P598	H - 220	2x
		4073	H - 197,5	1x
		4074	H - 197,5	1x
		4077	H - 197,5	1x

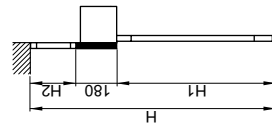
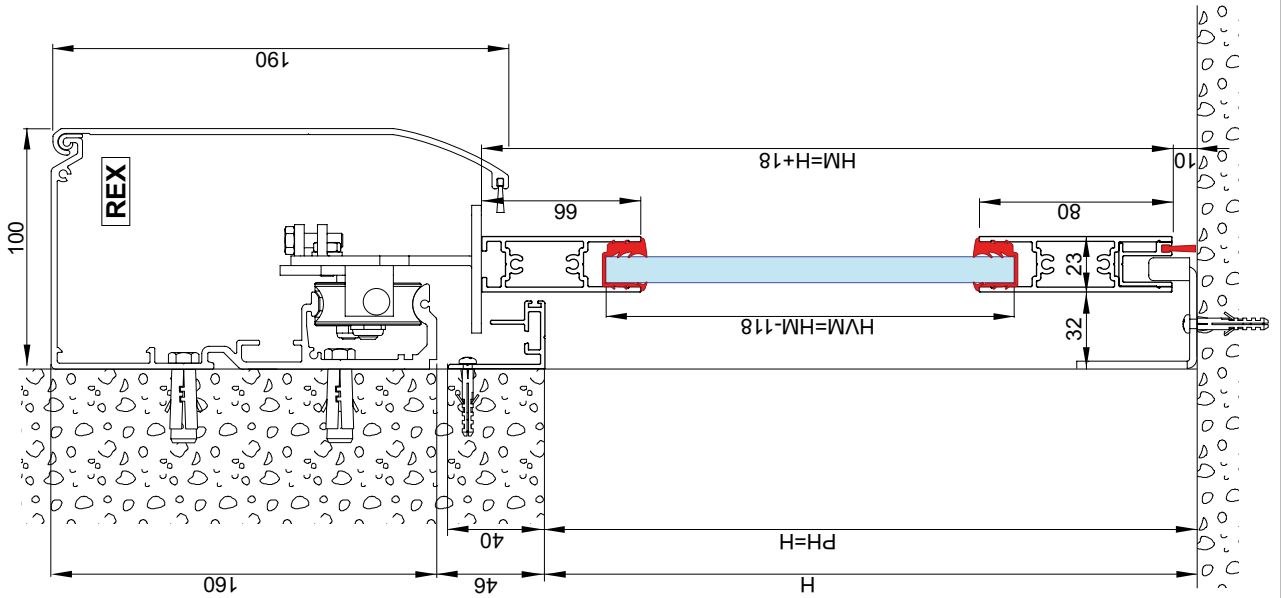

$PH = H1$
 $HM = H1 + 18,5$

Se il serramento
 comprende sopra-
 luce, consultare il manuale
 IP2049.
 If the door frame has
 the fanlight, see the
 IP2049 manual.

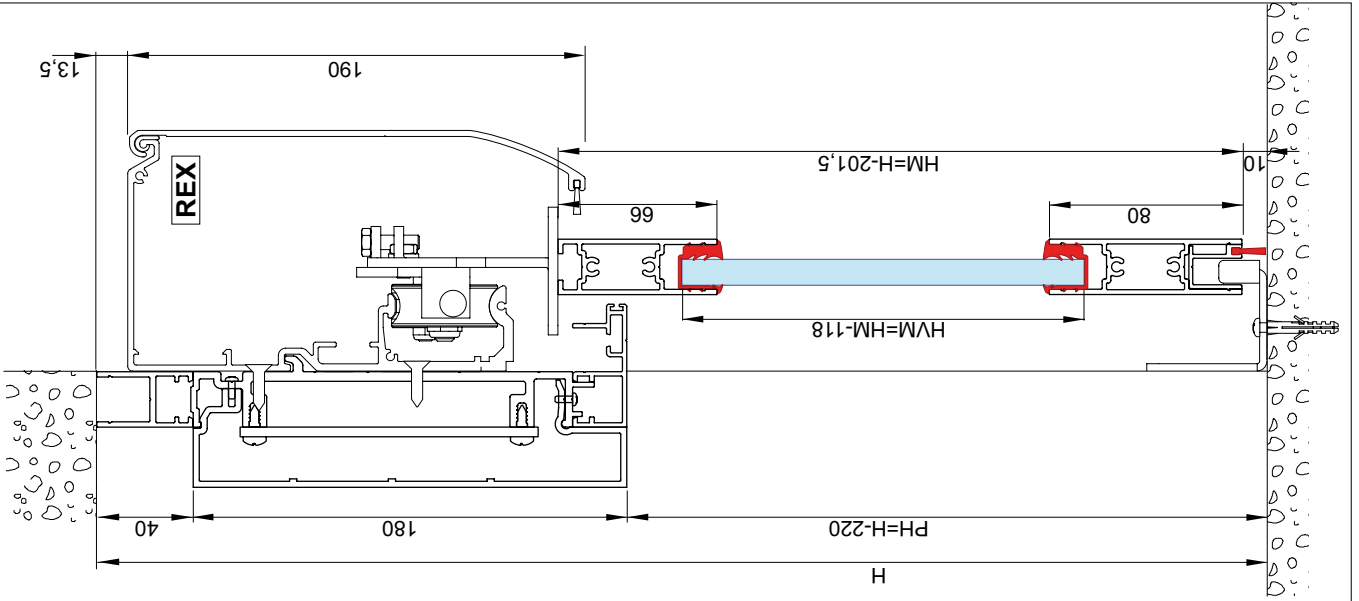

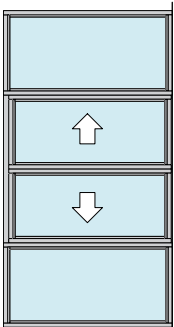

Vedi sezione orizzontale e distinta di taglio pag. 10-11-12.
See *horizontal section and cutting list* pag. 10-11-12.

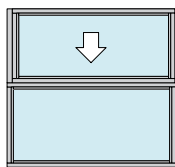

Vedi sezione orizzontale e distinta di taglio pag. 17-18.
See *horizontal section and cutting list* pag. 17-18.

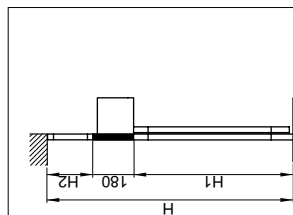

PH = H1
HM = H1 + 18,5
HF = H1 + 21,5
Se il serramento comprende sopraffice, consultare il manuale IP2049.
If the door frame has the fanlight, see the IP2049 manual.

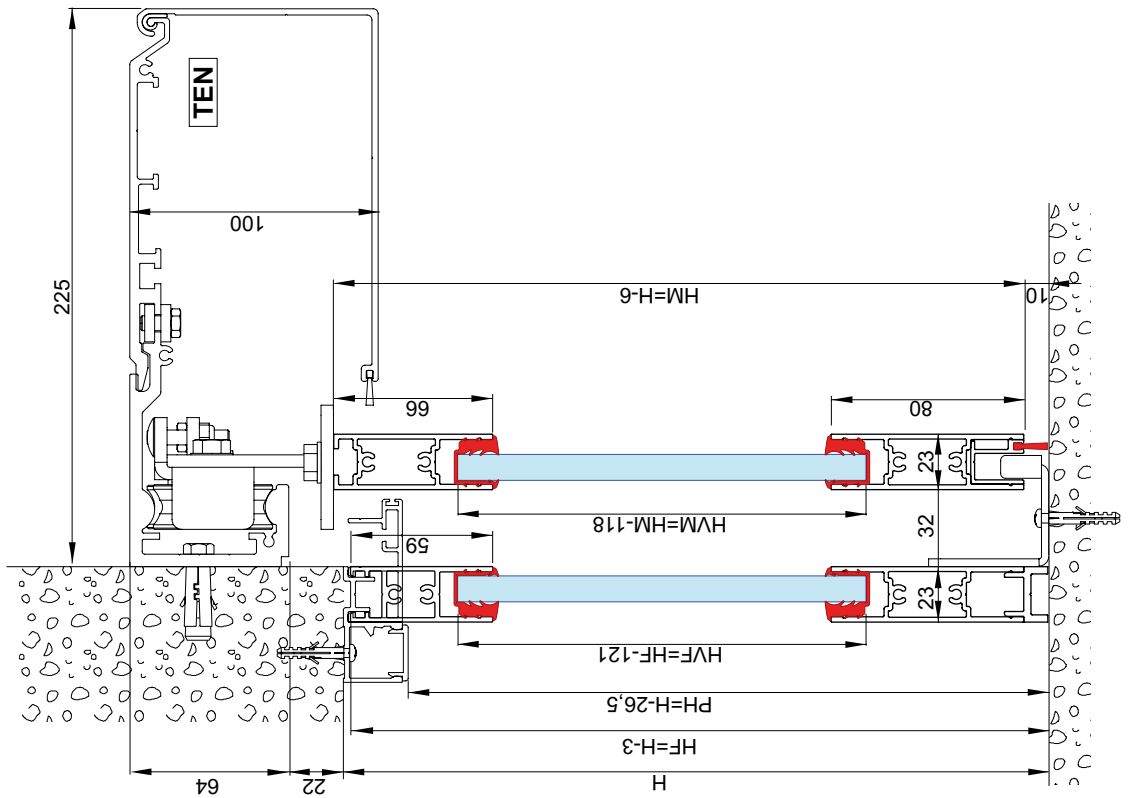
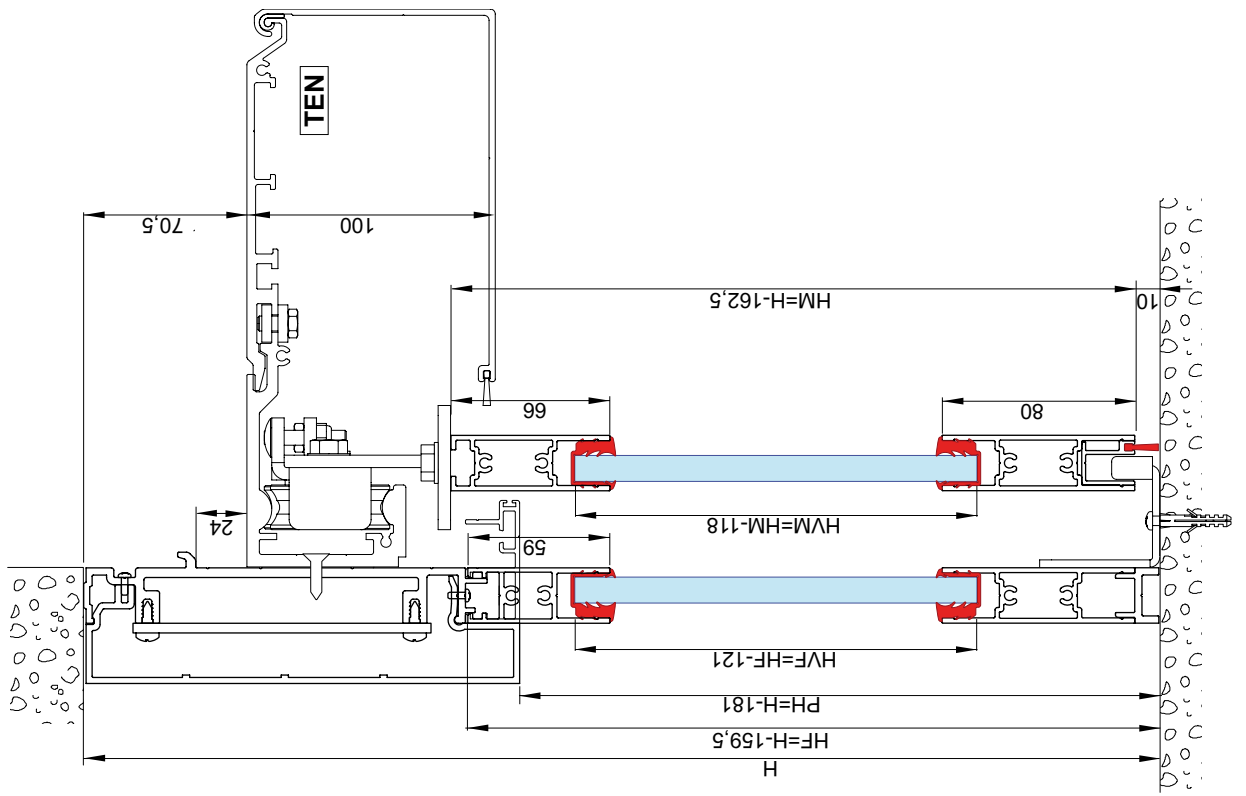

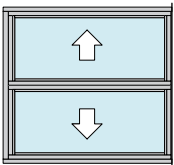

Vedi sezione orizzontale e distinta di taglio pag. 14-15.
See *horizontal section and cutting list* pag. 14-15.

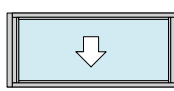

Vedi sezione orizzontale e distinta di taglio pag. 20-21.
See *horizontal section and cutting list* pag. 20-21.

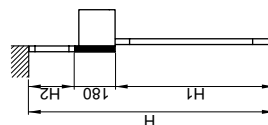

$PH = H1$
 $HM = H1 + 18,5$

Se il serramento comprende sopra-luce, consultare il manuale IP2049.

If the door frame has the fanlight, see the IP2049 manual.

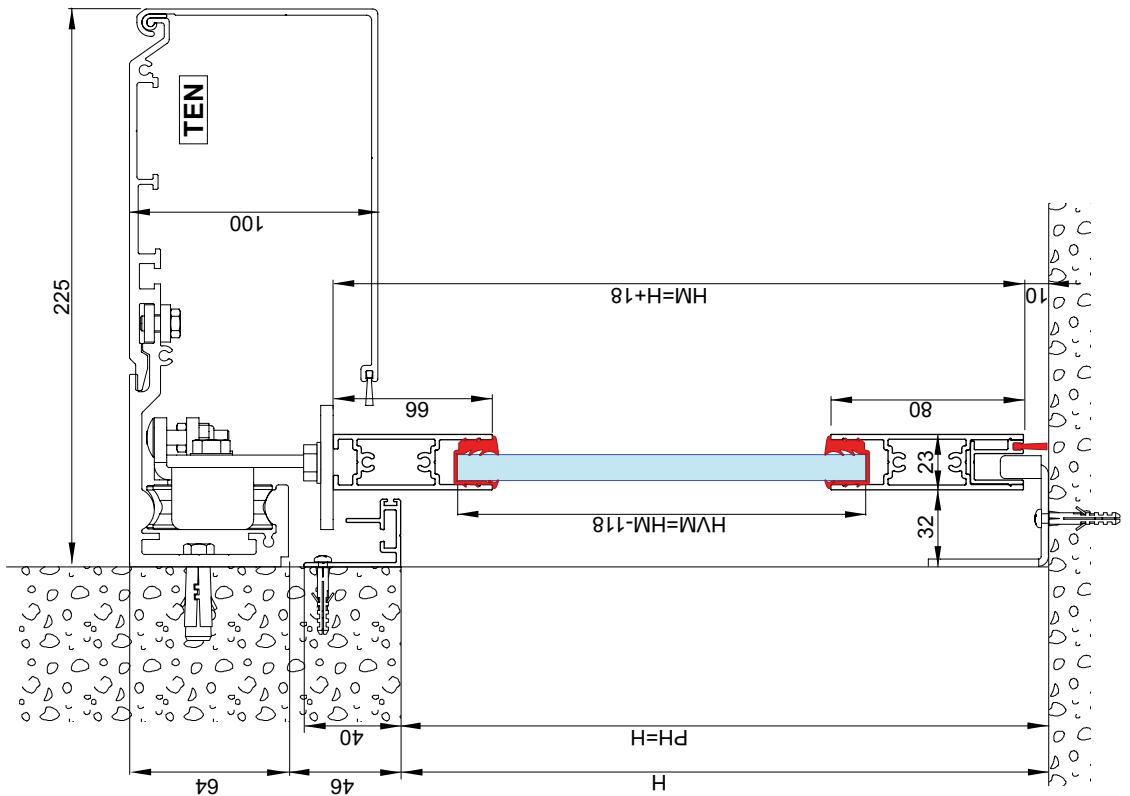
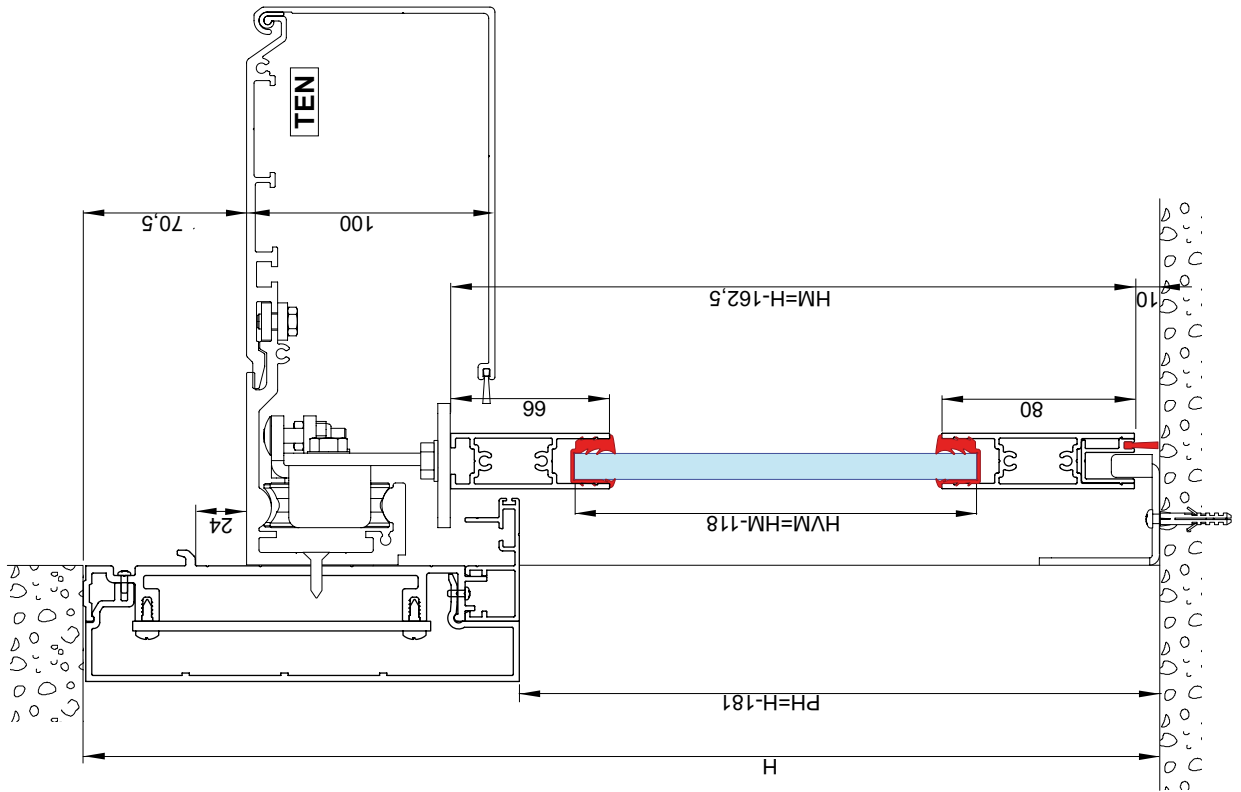

Tutti i diritti sono riservati

I dati riportati sono stati redatti e controllati con la massima cura. Tuttavia non possiamo assumerci alcuna responsabilità per eventuali errori, omissioni o approssimazioni dovute ad esigenze tecniche o grafiche.

All right reserved

All data and specifications have been drawn up and checked with the greatest care. The manufacturer cannot however take any responsibility for eventual errors, omissions or incomplete data due to technical or illustrative purposes.

Tous droits réservés

Les informations mentionnées dans ce catalogue ont été contrôlées avec la plus grande attention. Toutefois, nous déclinons toute responsabilité en cas d'erreurs, omissions ou approximations dépendant d'exigences techniques ou graphiques.

Alle Rechte vorbehalten

Die wiedergegebenen Daten wurden mit höchster Sorgfalt zusammengestellt und überprüft. Es kann jedoch keinerlei Verantwortung für eventuelle Fehler, Auslassungen oder Näherungen, die technischen oder graphischen Notwendigkeiten zuzuschreiben sind, übernommen werden.

Todos los derechos son reservados

Los datos que se indican han sido redactados y controlados con la máxima atención. Sin embargo no podemos asumir ninguna responsabilidad por eventuales errores, omisiones o aproximaciones debidas a exigencias técnicas o gráficas.

Todos os direitos são reservados

Os dados indicados foram redigidos e controlados com o máximo cuidado. Contudo, não podemos assumir qualquer responsabilidade por eventuais erros, omissões ou aproximações devidas a exigências técnicas ou gráficas.

DITEC S.p.A.

Via Mons. Banfi, 3
21042 Caronno P.Ia (VA)
ITALY

Tel. +39 02 963911
Fax +39 02 9650314

www.ditec.it
ditec@ditecva.com



Quarto d'Altino (VE)



Caronno Pertusella (VA)

DITEC BELGIUM

LOKEREN

Tel. +32 9 3560051
Fax +32 9 3560052

www.ditecbelgium.be



Lokeren



Oberursel

DITEC DEUTSCHLAND

OBERURSEL

Tel. +49 6171 914150
Fax +49 6171 9141555

www.ditec-germany.de

DITEC ESPAÑOLA

ARENYS DE MAR

Tel. +34 937958399
Fax +34 937959026

www.ditecespanola.com



Palaiseau



Balerna

DITEC FRANCE

PALAISEAU

Tel. +33 1 64532860
Fax +33 1 64532861

www.ditecfrance.com

DITEC GOLD PORTA

ERMESINDE

Tel. +22 977 35 20
Fax +22 977 35 28

www.goldporta.com

DITEC SVIZZERA

BALERNA

Tel. +41 91 6463339
Fax +41 91 6466127

www.ditecswiss.ch



Orlando

DITEC AMERICA

ORLANDO - FLORIDA - U.S.A.

Tel. +1 407 8880699
Fax +1 407 8882237

www.ditecamerica.com

DITEC CHINA

SHANGHAI

Tel. +86 21 62363861
Fax +86 21 62363863

www.ditec.cn

DITEC TURCHIA

ISTANBUL

Tel. +90 21 28757850
Fax +90 21 28757798

