

Ditec LOGIC M

IP1854EN

Control panel installation manual for 230 V~ automation with one or two motors

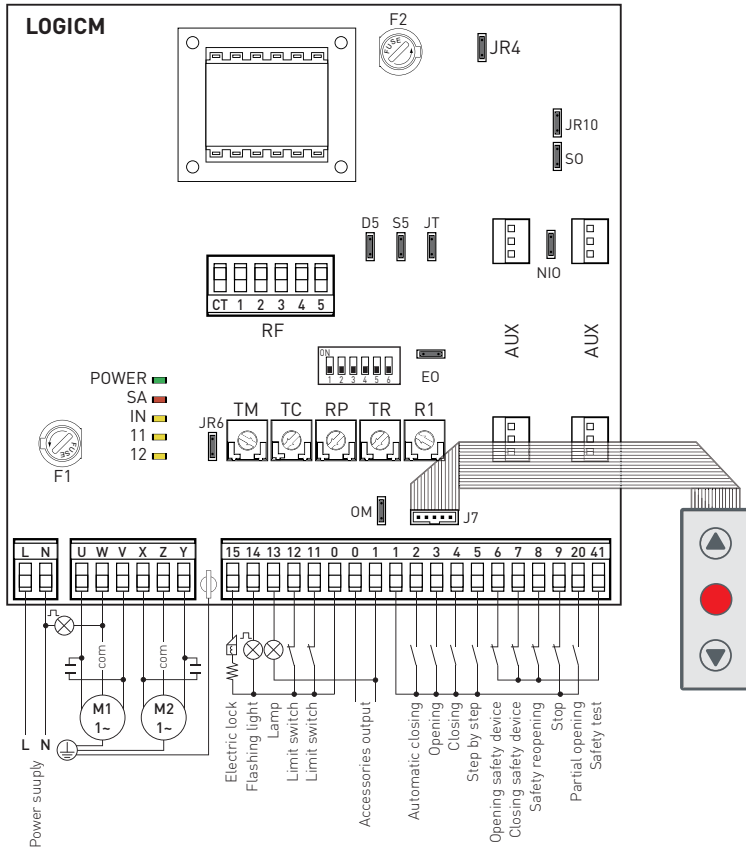

Index

	Subject	Page
1.	General safety precautions	26
2.	EC declaration of conformity	27
3.	Technical data	27
3.1	Applications	27
4.	Commands	28
4.1	Self-controlled safety edge	29
5.	Outputs and accessories	29
6.	Adjustments	31
6.1	Trimmer	31
6.2	Dip-switch	31
6.3	Jumper	32
6.4	Signals	32
7.	Start-up	33
8.	Troubleshooting	34
9.	Example application for two-motors swing gates	35
10.	Example application for one-motor swing gate	37
11.	Example application for sliding gate	39
12.	Example application for barrier	39
13.	Example of parallel	40

Caption



This symbol indicates instructions or notes regarding safety issues which require particular attention.



This symbol indicates informations which are useful for correct product function.

1. General safety precautions



This installation manual is intended for qualified personnel only.

Installation, electrical connections and adjustments must be performed in accordance with Good Working Methods and in compliance with applicable regulations.

Before installing the product, carefully read the instructions. Bad installation could be hazardous.



The packaging materials (plastic, polystyrene, etc.) should not be discarded in the environment or left within reach of children, as these are a potential source of hazard.

Before installing the product, make sure it is in perfect condition.

Do not install the product in an explosive environment and atmosphere: gas or inflammable fumes are a serious hazard risk.

Before installing the motors, make all structural changes relating to safety clearances and protection or segregation of all areas where there is risk of being crushed, cut or dragged, and danger areas in general.

Make sure the existing structure is up to standard in terms of strength and stability. The motor manufacturer is not responsible for failure to use Good Working Methods in building the frames to be motorized or for any deformation occurring during use.



The safety devices (photocells, safety edges, emergency stops, etc.) must be installed taking into account: applicable laws and directives, Good Working Methods, installation premises, system operating logic and the forces developed by the motorized door.

The safety devices must protect any areas where the risk exists of being crushed, cut or gragged, or where there are any other risks generated by the motorized door.

Apply hazard area notices required by applicable regulations.

Each installation must clearly show the identification details of the motorized door.

When necessary, connect the motorized door to a reliable earth system made in accordance with applicable safety regulations.

During installation, maintenance and repair, interrupt the power supply before opening the lid to access the electrical parts.

The protective casing of the automation must be removed by qualified personnel only.



To handle electronic parts, wear earthed antistatic conductive bracelets. The motor manufacturer declines all responsibility in the event of component parts being fitted that are not compatible with the safe and correct operation.

For repairs or replacements of products only original spare parts must be used. The installer shall provide all information relating to automatic, manual and emergency operation of the motorized door, and provide the user with operating instructions.

2. EC Declaration of conformity

The manufacturer Entrematic Group AB with headquarters in Lodjursgatan 10, SE-261 44 Landskrona, Sweden

declares that the control panel Ditec LOGICM is in conformity with the provisions of the following EC directives:

EMC Directive 2004/108/CE;

Low Voltage Directive 2006/95/CE.

Landskrona, 29-01-2013

Marco Pietro Zini
(President & CEO)



3. Technical data

	LOGICM	LOGICMJ
Power supply	230 V~ 50/60 Hz	120 V~ 60 Hz
F1 fuse	F6,3A	F6,3A
F2 fuse	F3,15A	F3,15A
One motor output	230 V~ 5A max	120 V~ 6,3A max
Two motor output	230 V~ 2x2,5A max	120 V~ 2x3,15A max
Accessories power supply	24 V= 0,5 A	24 V= 0,5 A
Temperature	min -20 °C max +55 °C	min -20 °C max +55 °C
Degree of protection	IP55	IP55
Dimensions	187X261X105	187X261X105



NOTE: the given operating and performance features can only be guaranteed with the use of DITEC accessories and safety devices.

3.1 Applications

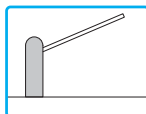
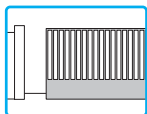
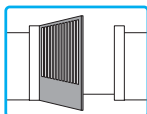
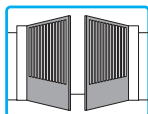

4. Commands

Command	Function	Description
1 — 2	N.O. AUTOMATIC CLOSING	Permanently closing the contact enables automatic closing.
1 — 3	N.O. OPENING	The opening operation starts when the contact is closed.
1 — 4	N.O. CLOSING	The closing operation starts when the contact is closed.
1 — 5	N.O. STEP-BY-STEP	With D5=ON closing the contact starts a sequential opening or closing operation: open-stop-close-open. With D5=OFF closing the contact starts a sequential opening or closing operation: open-stop-close-stop-open. Note: if automatic closing is enabled, with S5=ON the stop is not permanent but at a time that is set by the TC, with S5=OFF the stop is permanent.
41 — 6	N.C. OPENING SAFETY DEVICE	Opening the safety contact stops the current opening operation in progress and impedes any future opening operations.
41 — 7	N.C. CLOSING SAFETY DEVICE	Opening the safety contact stops the current closing operation in progress and impedes any future closing operations.
41 — 6 7	N.C. SAFETY STOP	Opening the safety contact stops and prevents any movement. Note: it does not carry out the disengagement operation. Use with photocells installed only.
41 — 8	N.C. REVERSAL SAFETY DEVICE	Opening the safety contact triggers a reversal of motion [re-opening] during a closing operation.
1 — 9	N.C. STOP	Opening the safety contact stops the current operation.
1 — 9	N.C. EMERGENCY STOP	To enable the emergency stop function (e.g. with a specific red button), connect the opening and closing controls to terminal 9 instead of 1 (9-3, 9-4, 9-20).
1 — 9	N.O. HOLD-TO-RUN FUNCTION	Permanently opening the safety contact enables the operator presence dependent function. In this state, the opening (1-3, 1-20) and closing (1-4) controls function only if held in the pressed position and the automation stops when the controls are released. All safety switches, the step-by-step control and the automatic closing function are disabled.
1 — 20	PARTIAL OPENING	Closing the contact activates a partial opening operation of the door wing powered by motor 1, of the duration set with the RP trimmer. Once the automation stops, the partial opening control performs the opposite operation to the one performed before stoppage.
0 — 11	N.C. M2 LIMIT SWITCH	With TC=MAX, the limit switch contact opening stops closing movement of motor 2 (M2). With OM=OFF (1 motor mode) and DIP2=OFF, the limit switch stops closing movement of motor 1 (M1). With OM=OFF (1 motor mode) and DIP2=ON, the limit switch stops opening movement of motor 1 (M1).
0 — 11	N.O. M2 PROXIMITY LIMIT SWITCH	See Chapters 9-10, example 4.
0 — 12	N.C. M1 LIMIT SWITCH	With TC=MAX, the limit switch contact opening stops closing movement of motor 1 (M1). With OM=OFF (1 motor mode) and DIP2=OFF, the limit switch stops opening movement of motor 1 (M1). With OM=OFF (1 motor mode) and DIP2=ON, the limit switch stops closing movement of motor 1 (M1).
0 — 12	N.O. M1 PROXIMITY LIMIT SWITCH	See Chapters 9-10, example 4.















WARNING: Make a jumper on all N.C. contacts if not in use. The terminals with the same number are equal.

4.1 Self-controlled safety edge SOFA1-SOFA2 or GOPAVRS

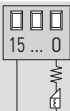
Command	Function	Description
	SAFETY TEST	Place the SOFA1-SOFA2 or GOPAVRS device into its housing for plug-in cards AUX. Connecting terminal 41 enables a safety edge test cycle before every operation. If the test fails the SA led flashes and the test is repeated.
1 — 6	N.C. OPENING SAFETY DEVICE	Connect the output contact of device SOFA1-SOFA2 to terminals 1-6 on the control panel (in series with the photocell output contact, if installed).
1 — 7	N.C. CLOSING SAFETY DEVICE	Connect the output contact of device SOFA1-SOFA2 to terminals 1-7 on the control panel (in series with the photocell output contact, if installed).
1 — 8	N.C. REVERSAL SAFETY DEVICE	Connect the output contact of device SOFA1-SOFA2 to terminals 1-8 on the control panel (in series with the photocell output contact, if installed). ATTENTION: for quick operation on the safety edge, connect it to contact 1-6 or to contact 1-7.

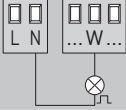
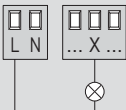
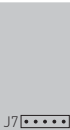
5. Uscite e accessori

Output	Value - Accessories	Description
	24 V \approx 0,5 A	Accessories power supply. Power supply output for external accessories, including automation status lamp. NOTE: the maximum absorption of 0.5 A corresponds to the sum of all terminals 1.
AUX	SOFA1-SOFA2 GOPAV	The control panel has two spaces for coupling board, type radio receivers, magnetic loops etc. The coupling board working mode is selected by DIP1. WARNING: the plug-in cards must be inserted and removed with the power supply disconnected.
	24 V \approx 3 W	Automation open lamp. Only with limit switch 0-11 (NC) connected and in one motor mode (jumper OM=OFF) will the lamp extinguish when automation is closed.
	24 V \approx 3 W	Automation closed lamp. Only with limit switch 0-12 (NC) connected and in one motor mode (jumper OM=OFF) will the lamp extinguish when automation is open.
	24 V \approx 3 W	Automation open lamp. A lamp lights up that extinguishes only when automation is closed.
	LAMP 24 V \approx 50 W	Flashing light. Activated during opening and closing operations.

Output	Value - Accessories	Description
	24 V \approx 1,2 A	<p>Accessories power supply. Power supply output for external accessories, including automation status lamp. NOTE: the maximum absorption of 0.5 A corresponds to the sum of all terminals 1.</p> <p>The control panel has two spaces for coupling board, type radio receivers, magnetic loops etc. The coupling board working mode is selected by DIP1. WARNING: the plug-in cards must be inserted and removed with the power supply disconnected.</p> <p>Automation open lamp. Only with limit switch 0-11 (NC) connected and in one motor mode (jumper OM=OFF) will the lamp extinguish when automation is closed.</p>
	12 V- 15 W	<p>Automation closed lamp. Only with limit switch 0-12 (NC) connected and in one motor mode (jumper OM=OFF) will the lamp extinguish when automation is open.</p>
	230 V- 2,5 A 120 V (LOGICMJ)	Automation open lamp. A lamp lights up that extinguishes only when automation is closed.
	230 V- 2,5 A 120 V (LOGICMJ)	Flashing light. Activated during opening and closing operations.
	LAMP 230 V- 100 W 120 V- (LOGICMJ)	Flashing light. Activated during opening and closing operations.
	230 V- 100 W 120 V- (LOGICMJ)	Courtesy light. In one motor mode only (jumper OM=OFF and no motor connected to terminals X-Z-Y), a courtesy light may be connected, which activates for 180 s each time a total or partial opening command or closing command is received.
		Membrane push-button panel (PT3). Starts the opening operation. Note: to activate the closing operation, connect the connector of the push-button panel to J7 (rotated by 180°).
		Membrane push-button panel (PT3). Causes the blocking of the movement.
		Membrane push-button panel (PT3). Starts the closing operation. Note: to activate the opening operation, connect the connector of the push-button panel to J7 (rotated by 180°).

6. Adjustments



6.1 Trimmer

Trimmer	Description
<p>TM</p>	<p>Setting the operating time. From 10 to 120 s. From 10 to 150 s with OM=OFF and JR6=OFF. NOTE: with NC limit switch, set TM=MAX.</p>
<p>TC</p>	<p>Setting automatic closing time. From 0 to 120 s. With DIP3=OFF, once a safety switch has been activated, the counter starts as soon as the safety switch is released (for example, after passing through the photocells), and lasts for a period of time set with TC (50%). With DIP3=ON, the counter starts when automation is opened and lasts for the entire duration set with TC (100%). NOTE: after the activation of the stop command, once contact 1-9 has closed again, automatic closing is only enabled after a total, partial or step-by-step opening command.</p>
<p>RP</p>	<p>Setting motor 1 (M1) partial aperture. From 0 to 30 s.</p>
<p>TR</p>	<p>Setting motor 1 (M1) closing delay time. When closing, motor 1 (M1) starts after a delay set with TR from 0 to 30 s relative to M2. When opening, motor 2 (M2) starts after a delay of 3 s relative to M1. If TR=MIN, the door wings start simultaneously. NOTE: we recommend setting TR=MIN with non-overlapping door wings, and setting TR>3 s with overlapping door wings.</p>
<p>R1</p>	<p>Setting obstacle thrust. The control panel is equipped with a safety system that stops motion if an obstacle is encountered during an opening operation and either stops or reverses motion during a closing operation. R1=MIN gives maximum obstacle sensitivity (minimum thrust). R1=MAX disables detection (maximum thrust).</p>
<p>RF</p>	<p>Power setting. Sets voltage supplied to motor (1=MIN / 5=MAX).</p> <p>⚠ ATTENTION: disconnect the power supply before adjusting.</p>









6.2 Dip-switch

DIP	Description	OFF	ON
DIP1	Radio mode.	Step-by-Step.	Opening.
DIP2	Direction selection with OM=OFF (one motor mode).	Opens towards right.	Opens towards left.
DIP3	Restore automatic closing time.	50%	100%
DIP4	Automation status at power on. Indicates how the control panel considers automation when powered up.	Open. NOTE: with a limit switch installed, preferably set DIP4=OFF.	Closed. NOTE: if the automatic closing function is not used, preferably set DIP4=ON.
DIP5	Electric lock release.	Disabled.	Enabled.
DIP6	Preflashing set at 3 s.	Disabled during opening. Enabled only with automatic closing and with TC setting greater than 3 s.	Enabled for both opening and closing.

6.3 Jumper

Jumper	Description	OFF 	ON 
JR4	Overtravel reduction. Reduces the overtravel distance for the door wing.	Disabled. NOTE: set JR4=OFF is the motor is equipped with an electric brake.	Enabled. NOTE: preferably set JR4=ON if the door wing performs an excessive overtravel.
JR6	Application type.	Sliding gate.	Other applications.
NIO	Electronic antifreeze system. Maintains motor function even at low ambient temperatures. NOTE: for correct operation, the control panel must be exposed to the same ambient temperature as the motors.	Enabled. ATTENTION: do not use with LOGICMJ.	Disabled.
JR10	Maximum power at start.	Disabled. The motor starts with the voltage set with RF.	Enabled. The motor starts at maximum power for 1 s.
OM	Automation type.	One motor automation (M1 only).	Automation with two independent motors.
D5	Step-by-step sequence.	Open-stop-close-stop-open.	Open-stop-close-open.
S5	Step-by-step sequence stop duration.	Permanent. (Automatic closing disabled).	Temporary. (Automatic closing enabled).
JT	Closing operation time.	Set with TM+4 s. NOTE: set JT=OFF with hydraulic or friction gearmotor.	Automatic.
E0	Electric lock function.	Powered with automation closed.	Powered for 1 s at the beginning of the opening operation.
S0	Reversal safety switch function.	With automation stopped and contact 41-8 open, opening operations are permitted.	With automation stopped and 41-8 open, all operations are disabled.

6.4 Signals

LED	On	Flashing
POWER 	24 V power supply	/
SA 	Indicates that at least one of the safety contacts is open.	 Safety test failure (terminal 41). Operations count performed (only when control panel is switched on):  = 1000 operations  = 10000 operations
IN 	Activated at every command and adjustment to the dip-switch and jumper.	/
11 	Indicates that the 0-11 limit switch contact is open.	/
12 	Indicates that the 0-12 limit switch contact is open.	/

7. Starting

- Bridge the NC safety contacts with a jumper.
- Before starting up, check the application type selected. In the case of single door wing automation, set OM=OFF. For sliding gate automation, set JR6=OFF.
- Any limit switches installed must be adjusted so that they are triggered near the mechanical opening and closing end stops. Set TM=MAX.

NOTE: limit switches must be kept pressed until the operation has been completed.

- If no limit switches are installed, bridge terminals 0-11 and 0-12 with jumpers and set TM to half.
- Set RF=3 and R1 to half.
- Set TR>3 s in the case of automation with two overlapping door wings.
- Switch on power.



ATTENTION: The following operations are performed with no safety devices

- Swap the motor polarity if the direction of motion of the door wings is incorrect.
- NOTE: the first closing operation requested after a power outage is performed, if TR>MIN, with one door wing at a time (first the door wing powered by motor M2, then the door wing powered by motor M1), whereas if TR=MIN, the door wings start simultaneously.
- Perform opening and closing commands and check that the automation functions correctly and that the limit switches (if installed) are correctly set.
 - Connect the safety devices (removing the relative jumpers) and check that they function correctly.
 - If required, activate automatic closing and adjust with the TC trimmer.
 - Set RF to a position that allows the automation to function correctly while ensuring the safety of the user in the event of collision.
 - Set obstacle thrust with R1.

NOTE: if the door wing closing second encounters an obstacle, both door wings are reopened. The subsequent closing operation is performed one door wing at a time.

- Ensure that the forces exerted by the door wings are compliant with EN12453-EN12445 regulations.
- If required, set the partial aperture of motor 1 with RP.
- If required, connect the radio receiver to the relative AUX connector, programme the transmitters as described in the relative manual and check that all elements function correctly.



WARNING: the plug-in cards must be inserted and removed with the power supply disconnected.

- Connect any other accessories and check operation.
- Once the start up and check procedures are completed, close the container.



NOTE: in the event of servicing or if the control panel is to be replaced, repeat the start-up procedure.

8. Troubleshooting

Problem	Possible causes	Remedy
Automation does not open or close.	No power. (POWER led off).	Check that the control panel is powered correctly.
	Short circuited accessories. (POWER led off).	Disconnect all accessories from terminals 0-1 (voltage must be 24 V-) and reconnect one at a time.
	Blown line fuse. (POWER led off).	Replace fuse.
	Safety contacts are open. (SA led on).	Check that the safety contacts are closed correctly (N.C.).
	Safety contacts not correctly connected or self-controlled safety edge SOFA1-SOFA2 not functioning correctly. (SA led flashing).	Check connections to terminals 6-7-8 on control panel and connections to the self-controlled safety edge SOFA1-SOFA2.
	Release microswitch open (if installed).	Check that the hatch is closed correctly and the microswitch makes contact.
	The motor thermal overload switch is open.	Check for continuity between the phases of the motors disconnected from the control panel.
Automation opens but does not close.	Safety contacts are open. (SA led on).	Check that the safety contacts are closed correctly (N.C.).
	Safety contacts not correctly connected or self-controlled safety edge SOFA1-SOFA2 not functioning correctly. (SA led flashing).	Check connections to terminals 6-7-8 on control panel and connections to the self-controlled safety edge SOFA1-SOFA2.
	Photocells activated. (SA led on).	Check that the photocells are clean and operating correctly.
	The automatic closing does not work.	Check that contact 1-2 is closed.
External safety devices not activating.	Incorrect connections between the photocells and the control panel.	Connect NC safety devices together in series and remove any bridges on the control panel terminal board.

9. Example application for two-motors swing gates

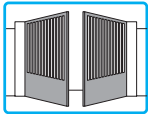

When the LOGICM control panel is used in automation applications with two swinging door wings, one of the following operating modes may be selected.

Example 1 - Door wings stop against mechanical end stops and in the event of obstacle detection.

Set an operating time of 2-3 s longer than the effective time taken by the door wing (TM<MAX) and bridge terminals 0-11-12 with jumpers. In this configuration, each door wing will come to a stop against mechanical opening and closing end stops and in the event of obstacle detection.

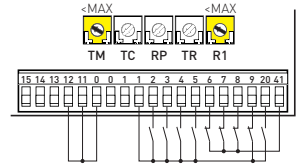

Example 2 - Door wings stop against limit switches and in the event of obstacle detection.

The NC contacts of the opening and closing limit switches are connected in series with the motor phases.

Set an operating time TM<MAX and bridge terminals 0-11-12 with jumpers.

In this configuration, each door wing will come to a stop against the opening and closing limit switches and in the event of obstacle detection.

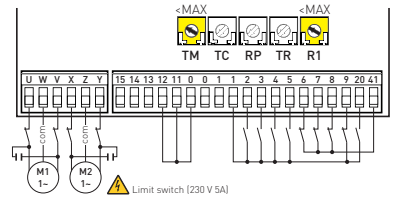

Example 3 - Door wings stop against limit switches and reverse motion in the event of obstacle detection.

Set an operating time TM=MAX and connect the closing limit switch NC contacts to terminals 0-11-12 and the opening limit switch NC contacts in series with the open phase of each motor.

With this configuration, each of the door wings stops when the limit switches are activated. In the event of obstacle detection while opening, only the door wing that detects the obstacle stops, performing a disengagement operation, whereas during a closing operation, both door wings reopen.

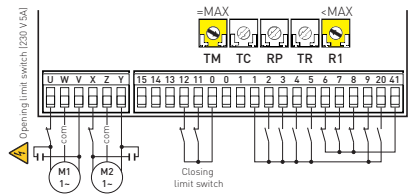

Example 4 - Door wings stop against mechanical end stops and reverse motion in the event of obstacle detection.

Set an operating time 2-3 s greater than the effective time taken by the door wing (TM<MAX) and connect the closing proximity limit switch NO contacts to terminals 0-11-12, positioning

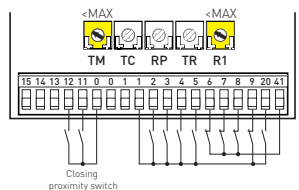

the switches 2-3 s ahead of the mechanical end stop. In this configuration, each door wing stops against its respective mechanical closing and opening end stop. In the event of obstacle detection while opening, only the door wing that detects the obstacle stops, performing a disengagement operation. In the event of obstacle detection during closing and before the activation of the proximity limit switch, the door wings reopen; after the activation of the proximity limit switch, the door wings stop against the obstacle.

Example 5 - The door wings stop against the limit switches when opening and against the mechanical end stops when closing, and reverse motion when an obstacle is detected.

Set an operating time 2-3 s greater than the effective time taken by the door wing ($TM < MAX$) and connect the closing proximity limit switches to terminals 0-11-12, positioning the switches 2-3 s ahead of the mechanical end stop. Connect the opening NC limit switches in series to the open phase of each motor. In this configuration, the door wing stops against the mechanical end stop when closing, and when the relative limit switch is activated when opening. When an obstacle is detected during opening, the door wing stops, performing a disengagement operation. In the event of obstacle detection during closing and before the activation of the proximity limit switch, the door wings reopen; after the activation of the proximity limit switch, the door wings stop against the obstacle.

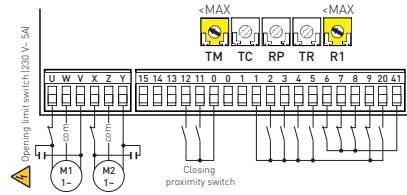

10. Example application for one-motor swing gate

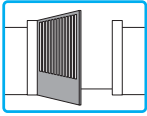

When the LOGICM control panel is used in automation applications with one swinging door wing, one of the following operating modes may be selected.

Example 1 - Door wing stops against mechanical end stops and in the event of obstacle detection.

Set an operating time of 2-3 s longer than the effective time taken by the door wing ($TM < MAX$) and bridge terminals 0-11-12 with jumpers. In this configuration, the door wing will come to a stop against mechanical opening and closing end stops and in the event of obstacle detection.

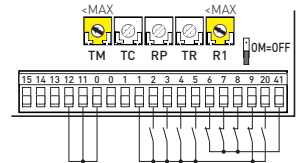

Example 2 - Door wing stops against limit switches and in the event of obstacle detection.

The NC contacts of the opening and closing limit switches are connected in series with the motor phases. Set an operation time $TM < MAX$ and bridge terminals 0-11-12 with jumpers. In this configuration, the door wing stops against the opening and closing limit switches and in the event of obstacle detection.

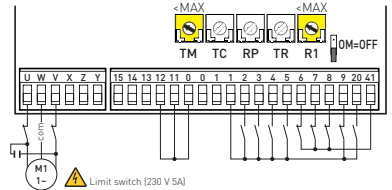

Example 3 - Door wing stops against limit switches and reverses motion in the event of obstacle detection.

Set an operating time $TM = MAX$ and connect the opening and closing limit switch NC contacts to terminals 0-11-12. In this configuration, the door wing stops when the limit switches are activated.

In this configuration, the door wing stops when the limit switches are activated.

In the event of obstacle detection while opening, the door wing stops, performing a disengagement operation, whereas during a closing operation, the door wing reopens.

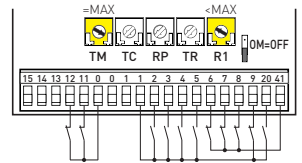

Opening limit switch
Closing limit switch

Example 4 - Door wing stops against mechanical end stops and reverses motion in the event of obstacle detection.

Set an operating time of 2-3 s longer than the effective time taken by the door wing ($TM < MAX$) and position the proximity limit switches 2-3 s ahead of the mechanical end stop.

In this configuration, the door wing stops against its respective mechanical closing and opening end

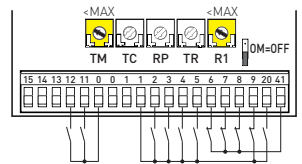

Opening proximity switch
Closing proximity switch

stop.

In the event of obstacle detection before the activation of the proximity limit switch while opening, the door wing stops, performing a disengagement operation; after the proximity limit switch is activated, the door wing stops against the obstacle.

In the event of obstacle detection during closing and before the activation of the proximity limit switch, the door wing reopens; after the proximity limit switch is activated, the door wing stops against the obstacle.

Example 5 - The door wing stops against the limit switch when opening and against the mechanical end stop when closing, and reverses motion in the event of obstacle detection.

Set an operating time of 2-3 s longer than the effective time taken by the door wing ($TM < MAX$), position the proximity limit switches 2-3 s ahead of the mechanical end stop and connect the opening limit switch NC in series to the opening phase of the motor.

In this configuration, the door wing stops against the mechanical end stop when closing, and when the relative limit switch is activated when opening. When an obstacle is detected during opening, the door wing stops, performing a disengagement operation. In the event of obstacle detection during closing and before the activation of the proximity limit switch, the door wing reopens; after the proximity limit switch is activated, the door wing stops against the obstacle.

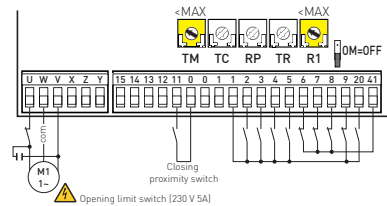

11. Example application for sliding gate

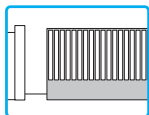

When using the LOGICM control panel for sliding automation applications:

- set OM=OFF
- set JR6=OFF
- set TM=MAX (150 s).

Connect the opening and closing limit switch NC contacts to terminals 0-11-12.

With this configuration, the door wing stops when the limit switches are activated.

In the event of obstacle detection while opening, the door wing stops, performing a disengagement operation, whereas during a closing operation, the door wing reopens.

Select the correct opening direction with DIP2.

- In the event of automation with right-side opening seen from the automation side (DIP2=OFF), connect the opening limit switch to terminals 0-12 and closing limit switch to terminals 0-11.
- In the event of automation with left-side opening seen from the automation side (DIP2=ON), connect the opening limit switch to terminals 0-11 and the closing limit switch to terminals 0-12.

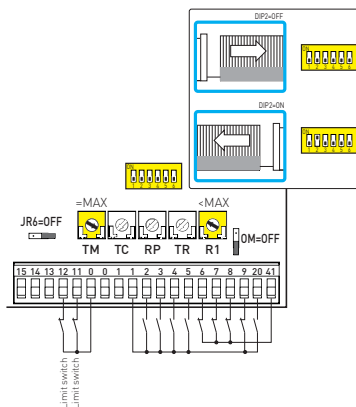

12. Example application for barriers

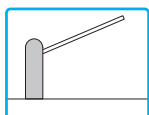

When using the LOGICM control panel for barrier applications:

- set OM=OFF
- set RF=5 (MAX)
- set TM=MAX

Select the correct opening direction with DIP2.

- In the event of automation with right-side opening seen from the automation side (DIP2=OFF), connect the opening limit switch to terminals 0-12 and closing limit switch to terminals 0-11.
- In the event of automation with left-side opening seen from the automation side (DIP2=ON), connect the opening limit switch to terminals 0-11 and the closing limit switch to terminals 0-12.

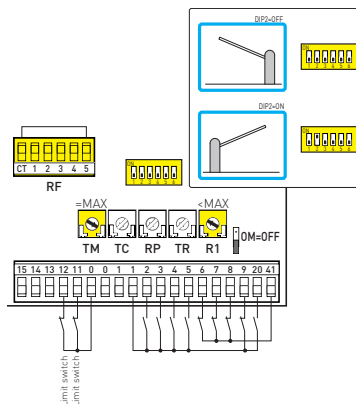

13. Example of automation in parallel

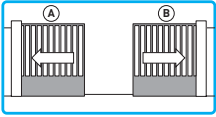

The two automations [A] and [B] can be operated in parallel by making the connections indicated in the figure.

Commands 1-3 and the remote controls (with DIP1=ON) are equivalent to a total opening command. Automatic closing is obtained by adjusting the TC trimmer not at the maximum and in the same position on both control panels.

i N.B.: the opening and closing movements are not synchronised, including reopening after activation of the photocells.

! **WARNING:** in the absence of safety edge SOFA1-SOFA2, connect commands 1-8 to the SWT card.
 Commands 41-6 and 41-7 can only be connected on the respective control panel.

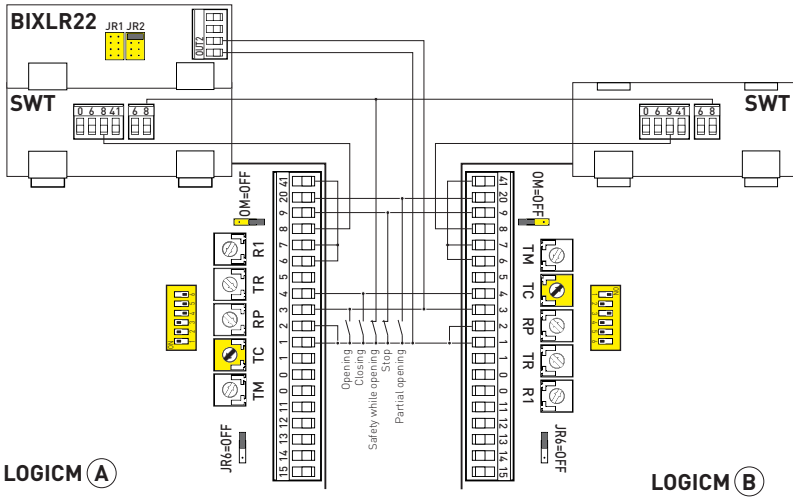

All the rights concerning this material are the exclusive property of Entrematic Group AB. Although the contents of this publication have been drawn up with the greatest care, Entrematic Group AB cannot be held responsible in any way for any damage caused by mistakes or omissions in this publication. We reserve the right to make changes without prior notice. Copying, scanning and changing in any way are expressly forbidden unless authorised in writing by Entrematic Group AB.

ENTRE//MATIC



Entrematic Group AB
Lodjursgatan 10
SE-261 44, Landskrona
Sweden
www.entrematic.com

